

mathématiques 10e année

le mardi 28 novembre 2023

Mme Barton

mai 30-10:05

Géométrie, Mesure, Finances 10

But: Géométrie - G5

Démontrer sa compréhension des angles, y compris les angles aigus, droits, obtus, plats et réflexes en : dessinant, répliquant et construisant, divisant en deux parties égales et en résolvant des problèmes.

mai 31-08:43

Géométrie, Mesure, Finances 10

But: Géométrie - G4

Résoudre des problèmes portant
sur des lignes parallèles,
perpendiculaires et transversales
et sur les paires d'angles formés
entre elles.

mai 31-08:43

**Les angles
et
les droites**

mai 30-10:06

Les angles et les droites

Vocabulaire nécessaire

mai 30-10:06

La somme des angles
d'un triangle est

180 degrés.



$$a + b + c = 180^\circ$$

mai 28-16:26

La somme des angles
d'un quadrilatère est

360 degrés.

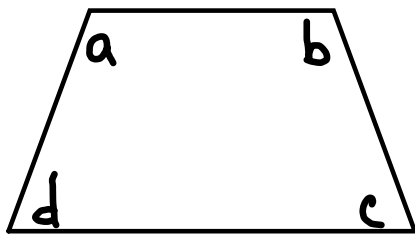

$$a + b + c + d = 360^\circ$$

mai 28-16:26

La somme des angles
d'un triangle est 180 degrés.



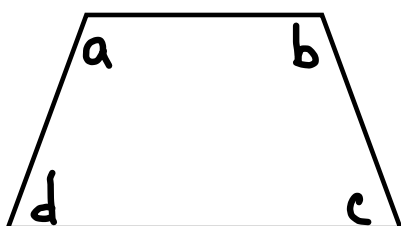

$$a + b + c = 180^\circ$$

La somme des angles
d'un quadrilatère est 360 degrés.





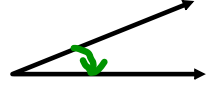
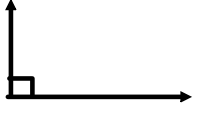

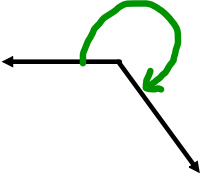
$$a + b + c + d = 360^\circ$$

mai 28-16:26

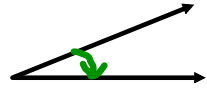
<u>Les angles</u>		
<u>Type d'angle</u>	<u>Mesure</u>	<u>Exemple</u>
_____	entre 0 et 90 degrés	
_____	90 degrés	
_____	entre 90 et 180 degrés	
_____	180 degrés	
_____	entre 180 et 360 degrés	
(ou _____)		

mai 23-12:20

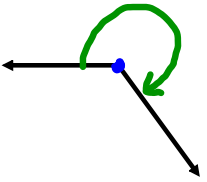
<u>Les angles</u>		
<u>Type d'angle</u>	<u>Mesure</u>	<u>Exemple</u>
angle aigu	entre 0 et 90 degrés	
angle droit	90 degrés	
angle obtus	entre 90 et 180 degrés	
angle plat	180 degrés	
angle rentrant (ou angle <u>réflexe</u>)	entre 180 et 360 degrés	

mai 23-12:20

Les angles

angles opposés

les angles opposés sont toujours égaux

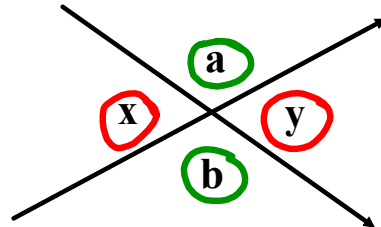

angle x = angle y

angle a = angle b

mai 23-19:35

Les angles

angles complémentaires

deux angles qui ont
une somme de 90°

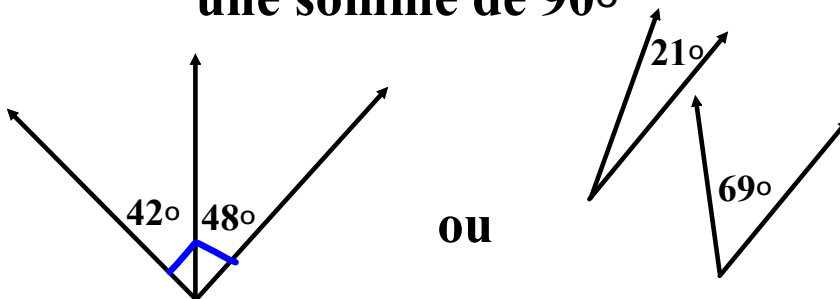

mai 23-19:45

Les angles

angles supplémentaires

deux angles qui ont
une somme de 180°

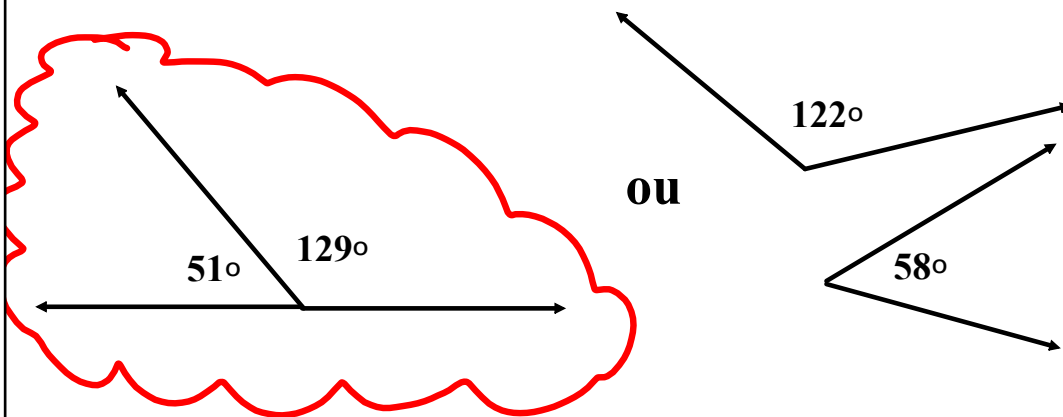

mai 23-19:51

Bissection veut dire "division
en deux parties égales"

mai 30-10:00

Les angles

la bissectrice d'un angle

segment de droite qui sépare un angle en
deux parties égales

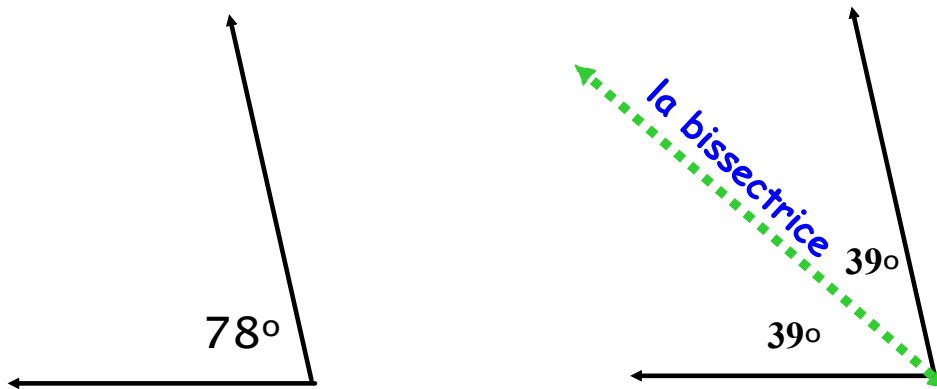

mai 23-19:51

Exercices

Les angles

Page # 1

Questions

1 à 5

mai 30-10:13

Exercices PAGE #1

① Classe les angles suivant qu'ils sont opposés, complémentaires ou supplémentaires.

a.

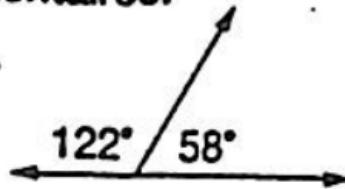

b.

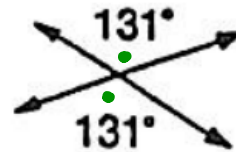

c.

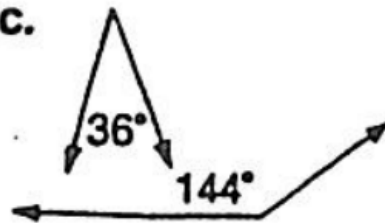

d.

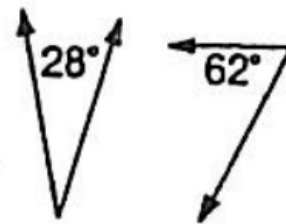

nov. 25-09:18

Réponses - Exercices - Page # 1

Question 1.

- a) supplémentaires
- b) opposés
- c) supplémentaires
- d) complémentaires

mai 30-10:09

② Nomme l'angle ou les angles. .

- a. droit b. plat
- c. rentrant d. opposés
- e. complémentaires
- f. supplémentaires

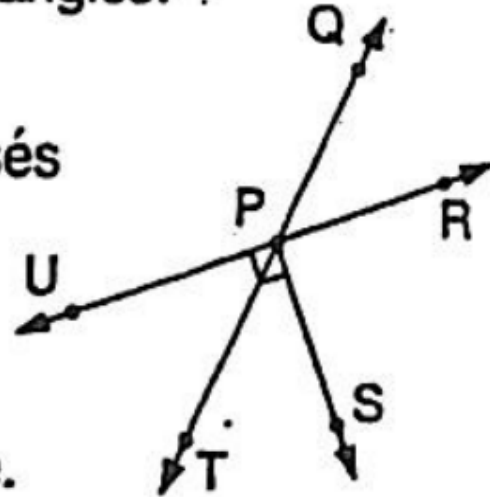

③ Reproduis et complète.

nov. 25-09:19

angles. .

sés

és.

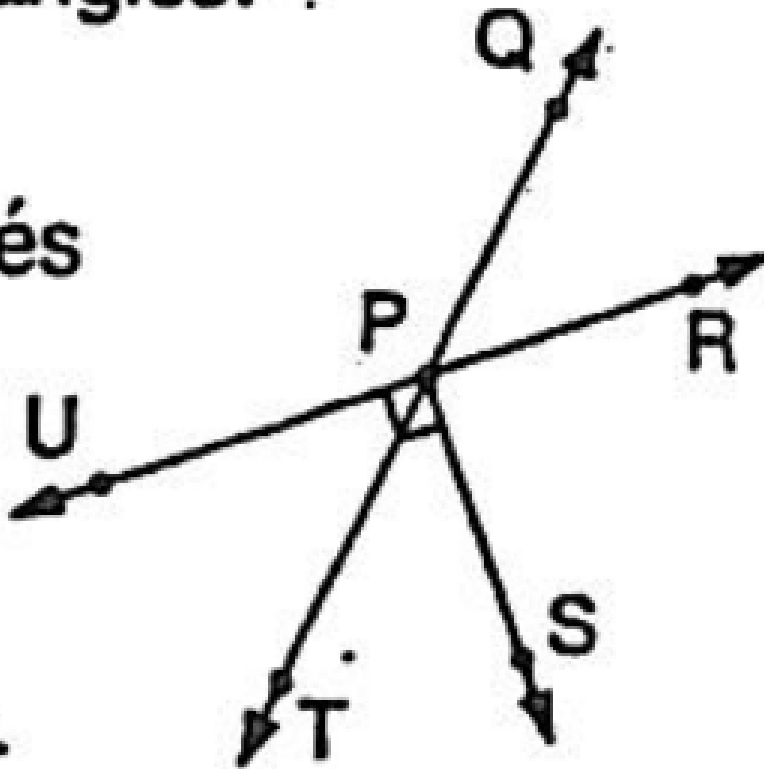

nov. 25-09:19

Question 2.

- ✓ a) angle droit - \angle SPU et \angle RPS
- ✓ b) angle plat - \angle UPR ou \angle QPT
- c) angle rentrant - \angle RPQ ou \angle SPR
- ✓ d) angles opposés - \angle QPR et \angle UPT } \angle UPQ et \angle TPR
- ✓ e) angles complémentaires - \angle SPT et \angle TPU
- f) angles supplémentaires - \angle UPQ et \angle QPR
 \angle UPQ et \angle TPU

mai 30-10:11

3) Reproduis et complète.

	Angle	Complément	Supplément
a.	40°	50°	140°
b.	72°		
c.	16°		
d.	90°		
e.	100°		
f.		20°	
g.			120°
h.			45°

nov. 25-09:28

Question 3.

<u>Angle</u>	<u>Complément</u>	<u>Supplément</u>
40°	50°	140°
72°	18°	108°
16°	74°	164°
90°	0°	90°
100°	----	80°
70°	20°	110°
60°	30°	120°
135°	----	45°

nov. 25-09:28

4. Combien mesurent les angles inconnus ?

a.

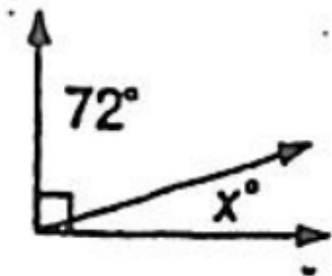

b.

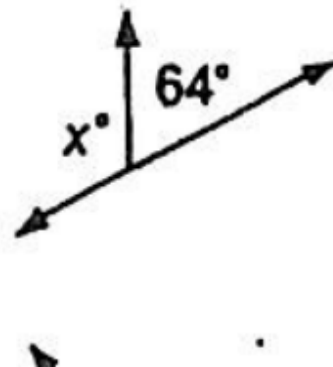

nov. 25-09:29

4. Combien mesurent les angles inconnus ?

a.

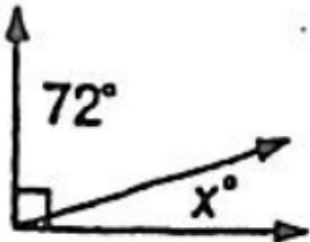

$x^\circ = 18^\circ$

angles complémentaires

b.

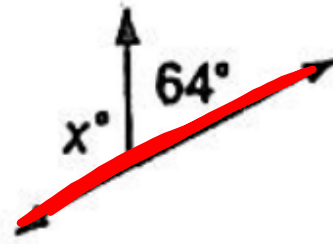

$x^\circ = 116^\circ$

angles supplémentaires

nov. 25-09:29

c.

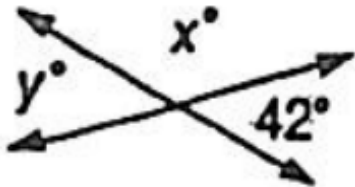

d.

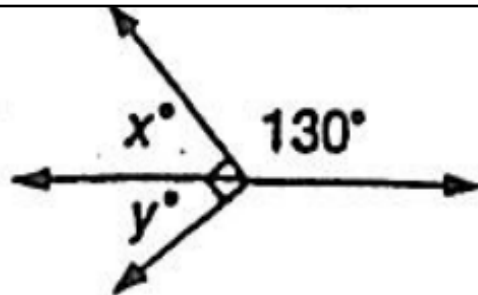

nov. 25-09:29

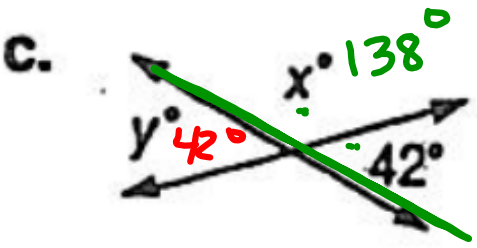
c. 

$y^\circ = 42^\circ$
 $x^\circ = 138^\circ$

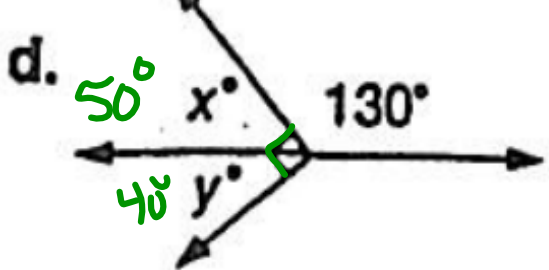
d. 

$x^\circ = 50^\circ$
 $y^\circ = 40^\circ$

nov. 25-09:29

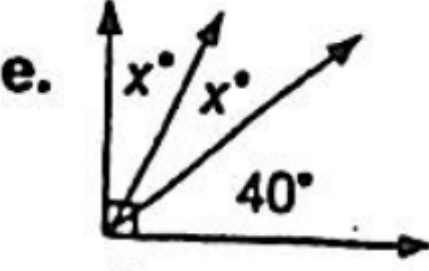
e. 

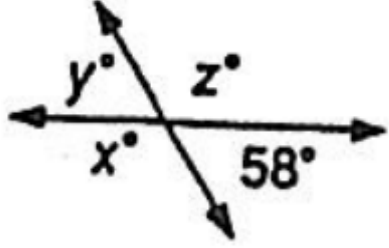
f. 

nov. 25-09:30

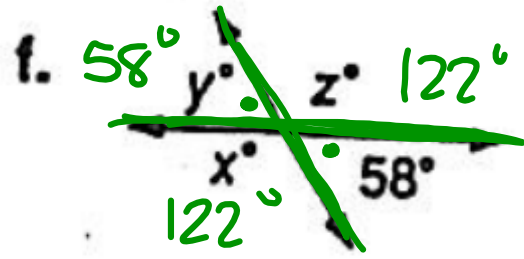
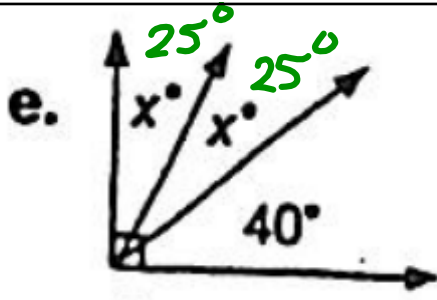

$$x^\circ = 25^\circ$$

nov. 25-09:30

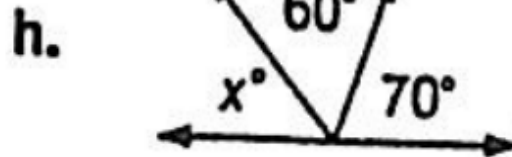
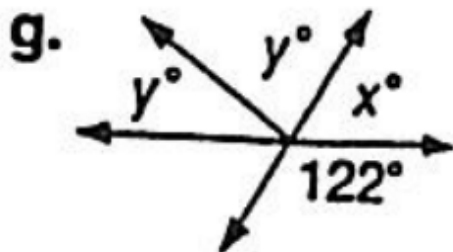

nov. 25-09:30

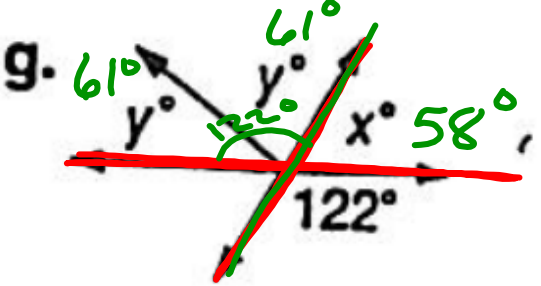
g. 

$122^\circ + x^\circ = \underline{\underline{180^\circ}}$
(58°)

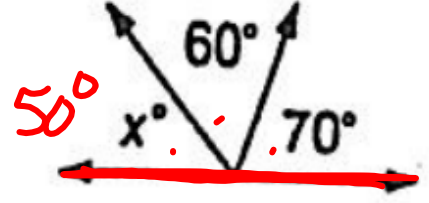
h. 

$= 180^\circ$

$x^\circ = 50^\circ$

nov. 25-09:30

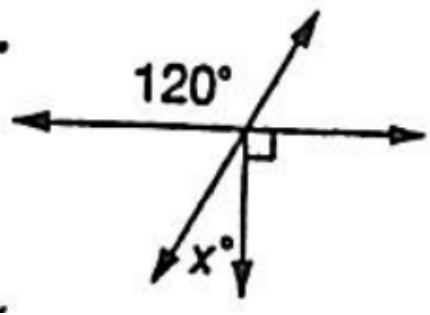
i. 

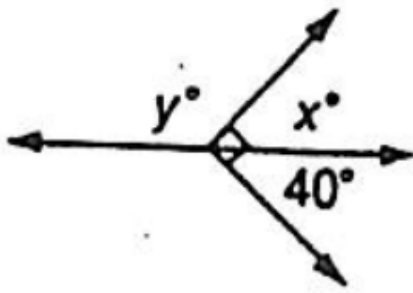
j. 

nov. 25-09:30

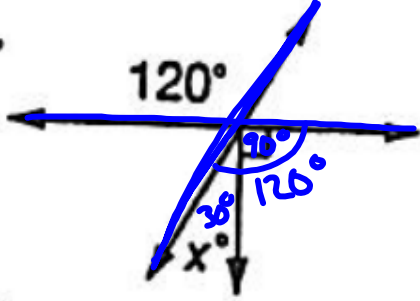
i. 

$120^\circ = 90^\circ + x^\circ$

$x^\circ = 30^\circ$

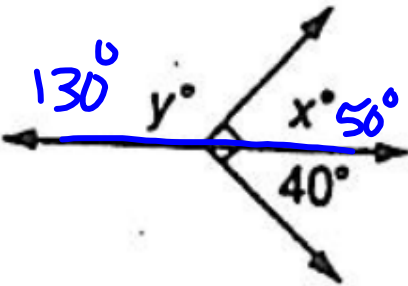
j. 

$x^\circ = 50^\circ$

$y^\circ = 130^\circ$

nov. 25-09:30

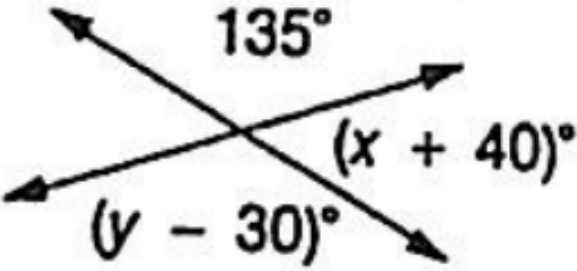
k. 

nov. 25-09:31

k.

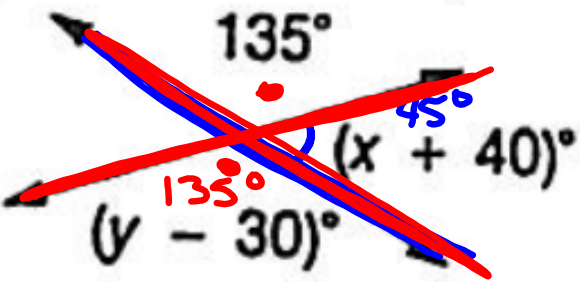

135°
 $(x + 40)^\circ$
 $(y - 30)^\circ$

$45^\circ = x + 40$
 $x = 5^\circ$

$135 = y - 30$
 $135 = 165 - 30$
 $y = 165^\circ$

nov. 25-09:31

l.

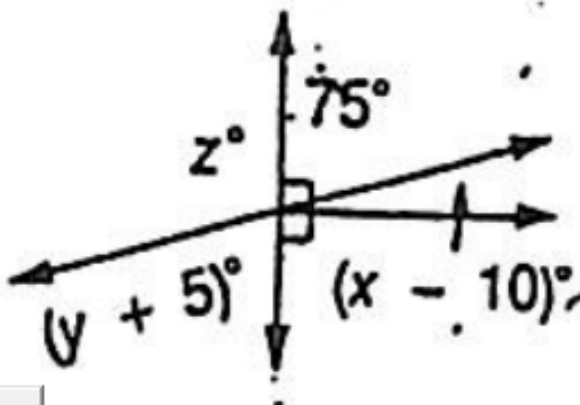

75°
 z°
 $(y + 5)^\circ$
 $(x - 10)^\circ$

nov. 25-09:31

l.

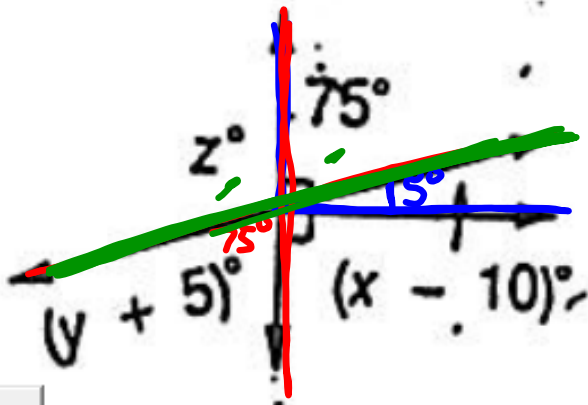

$75 + \underline{15} = 90$
 $x - 10 = 15$
 $x = 25^\circ$

$y + 5 = 75^\circ$
 $70^\circ + 5^\circ = 75^\circ$
 $y^\circ = 70^\circ$

$z^\circ = 105^\circ$

nov. 25-09:31

Question 4.

- a) $x = 18^\circ$
- b) $x = 116^\circ$
- c) $x = 138^\circ$ et $y = 42^\circ$
- d) $x = 50^\circ$ et $y = 40^\circ$
- e) $x = 25^\circ$
- f) $x = 122^\circ$ et $y = 58^\circ$ et $z = 122^\circ$
- g) $x = 58^\circ$ et $y = 61^\circ$
- h) $x = 50^\circ$
- i) $x = 30^\circ$
- j) $x = 50^\circ$ et $y = 130^\circ$
- k) $x = 5^\circ$ et $y = 165^\circ$
- l) $x = 25^\circ$ et $y = 70^\circ$

nov. 25-09:55

5. Calcule la mesure de l'angle inconnu.

a.

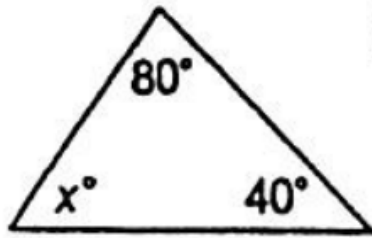

b.

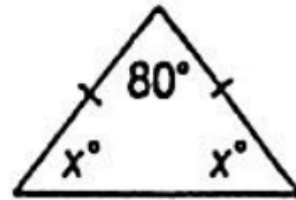

nov. 25-09:31

5. Calcule la mesure de l'angle inconnu.

a.

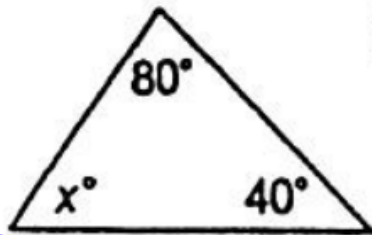

b.

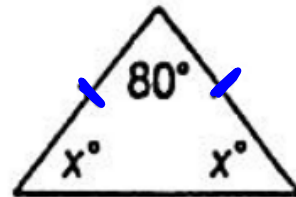

$x^\circ = 60^\circ$

Total: 180°

isocèles

$x + x = 100^\circ$
 $2x = 100$

$x = 50^\circ$

nov. 25-09:31

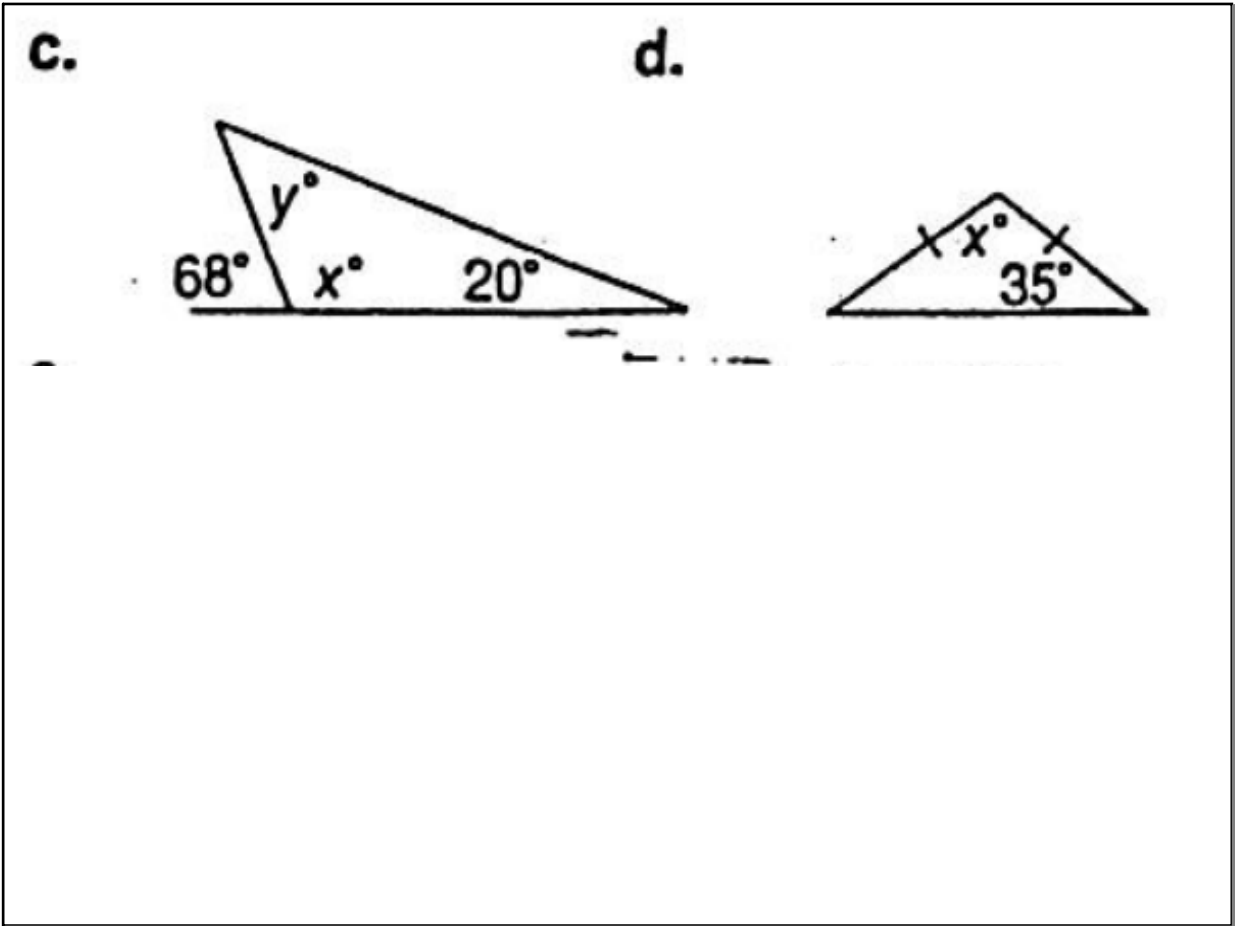

nov. 25-09:33

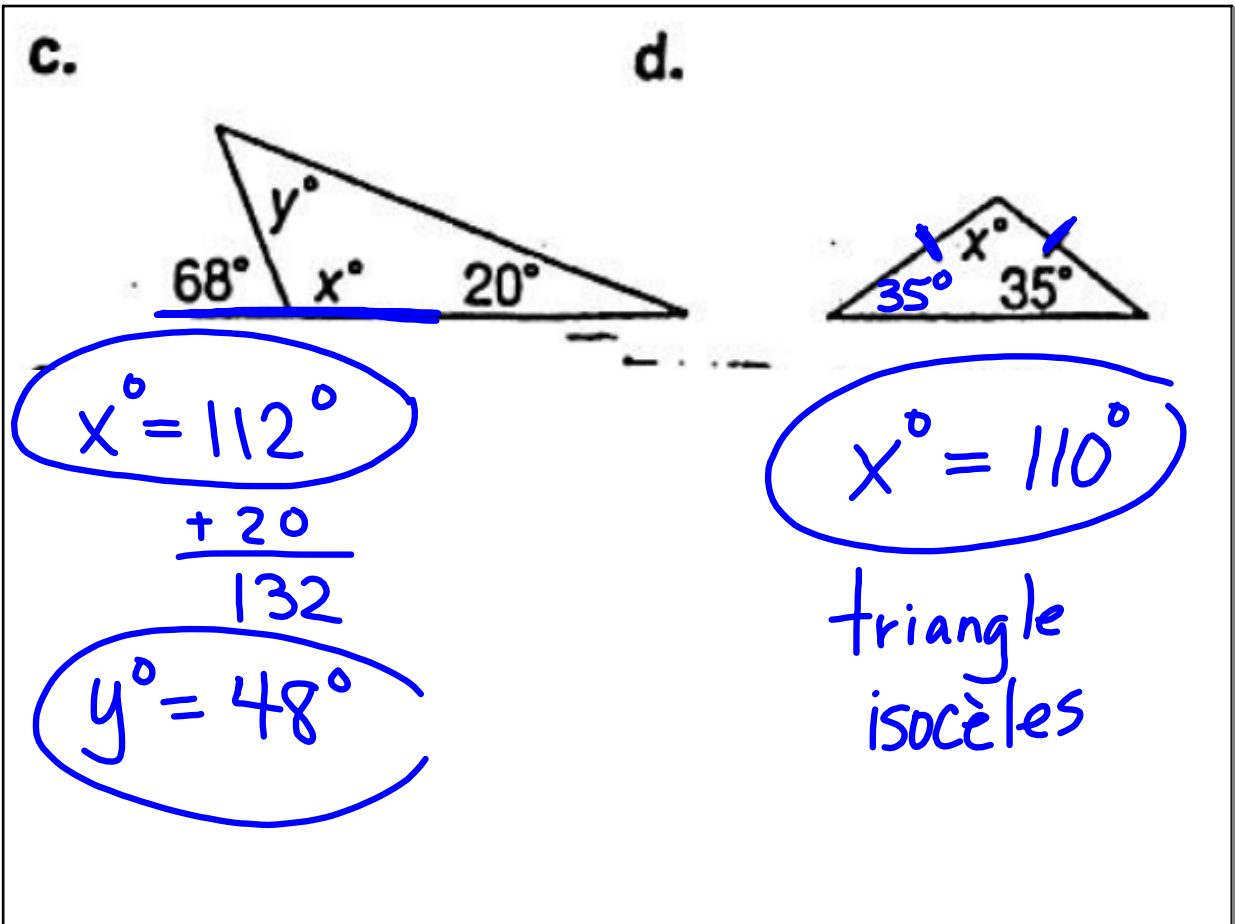

nov. 25-09:33

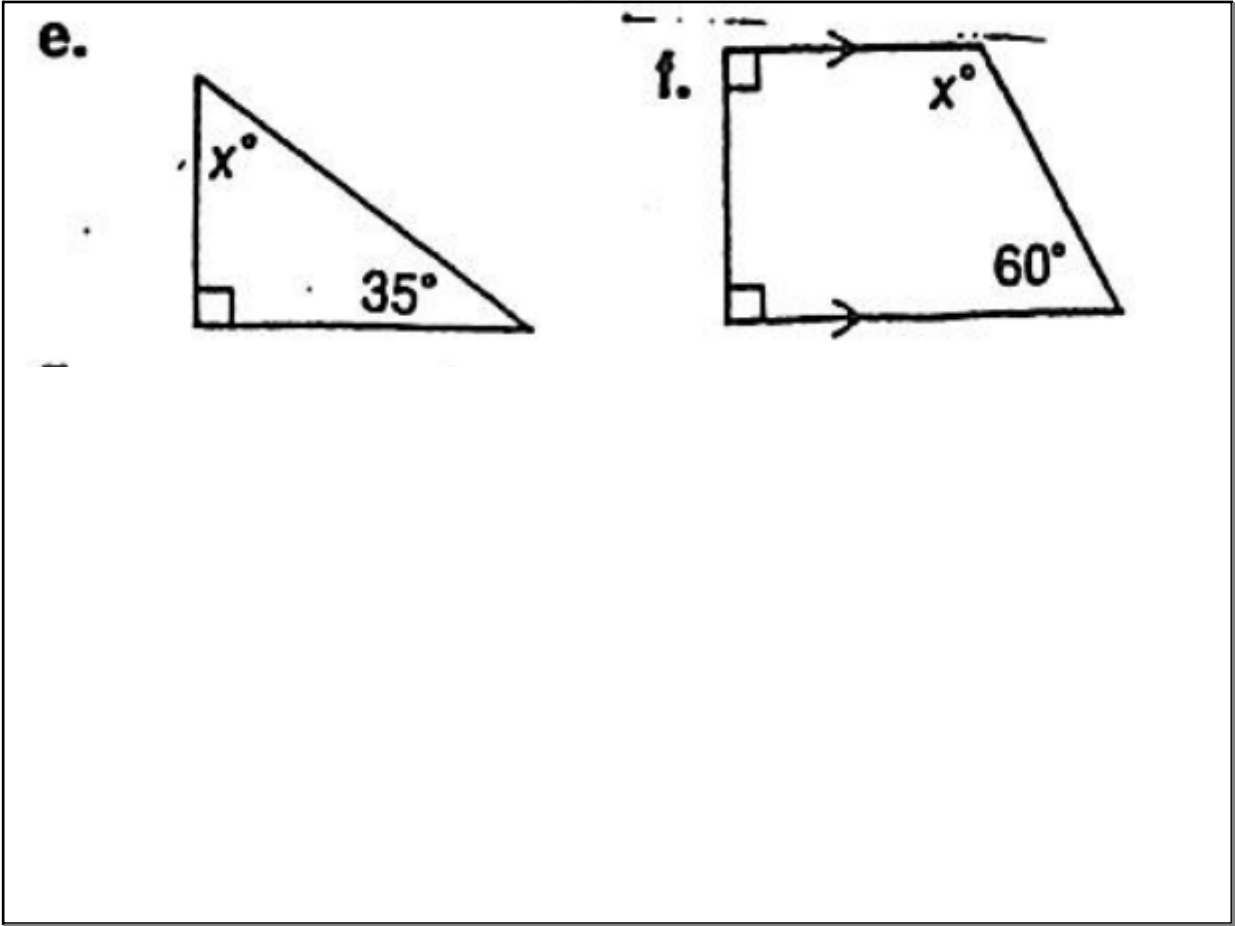

nov. 25-09:33

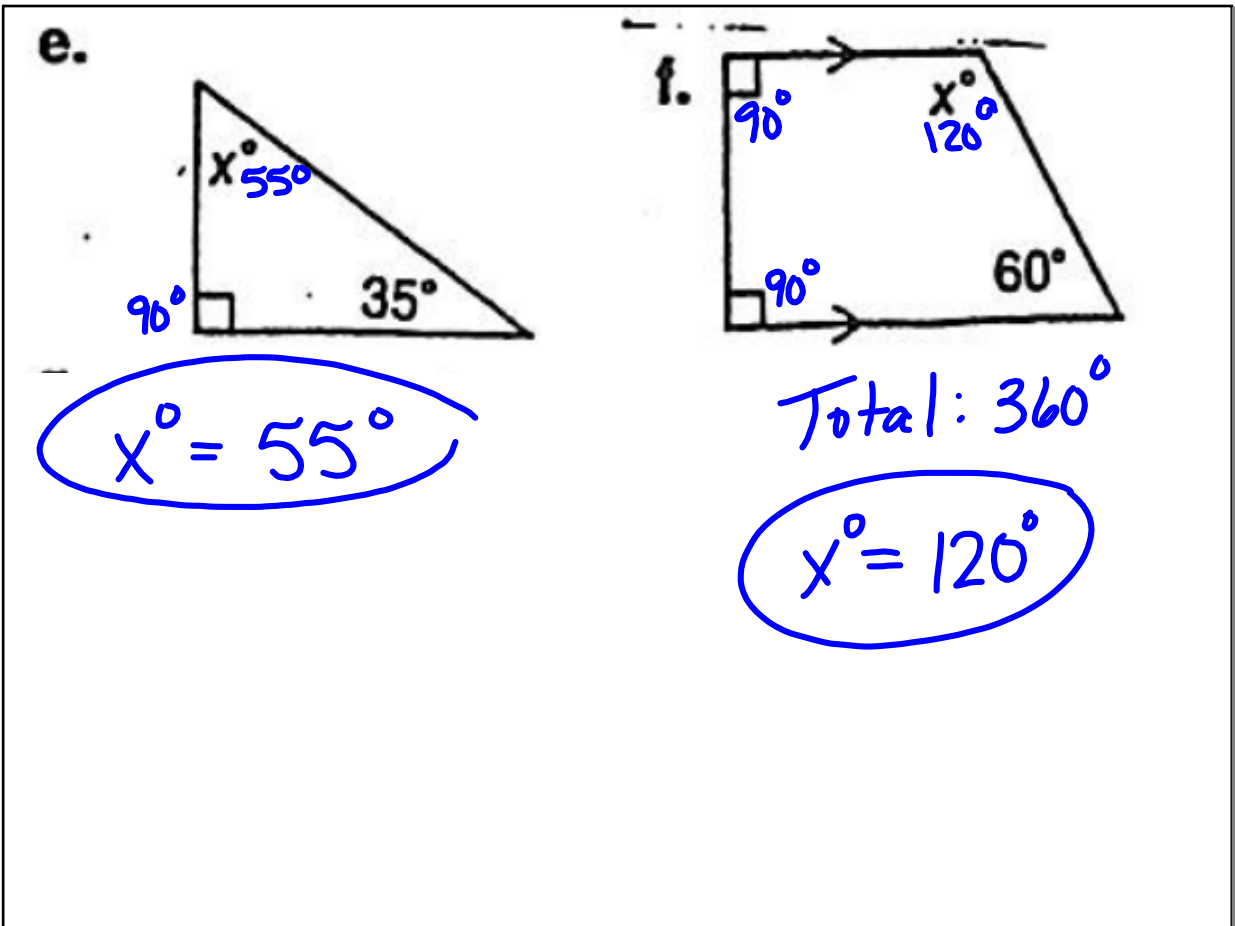

nov. 25-09:33

g.

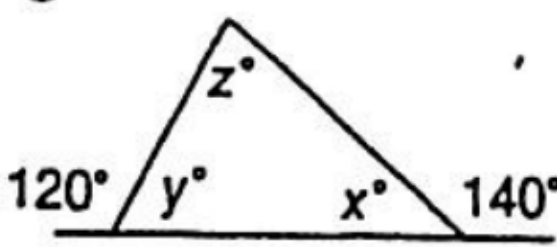

h.

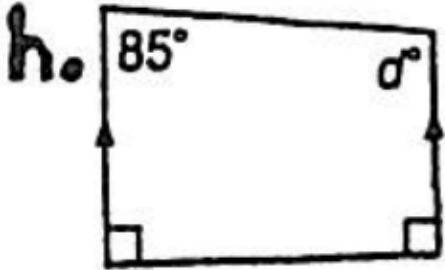

i.

nov. 25-09:34

g.

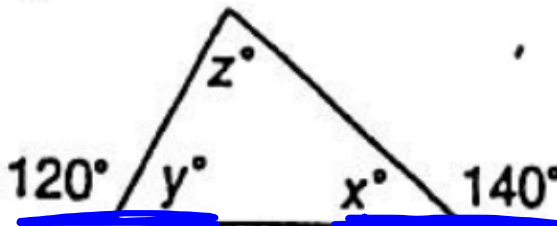

h.

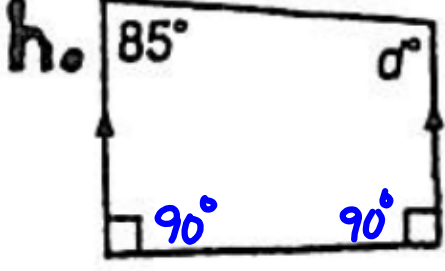

hm

$$x^\circ = 40^\circ$$
$$y^\circ = 60^\circ$$
$$z^\circ = 80^\circ$$
$$d^\circ = 95^\circ$$

Total: 360°

nov. 25-09:34

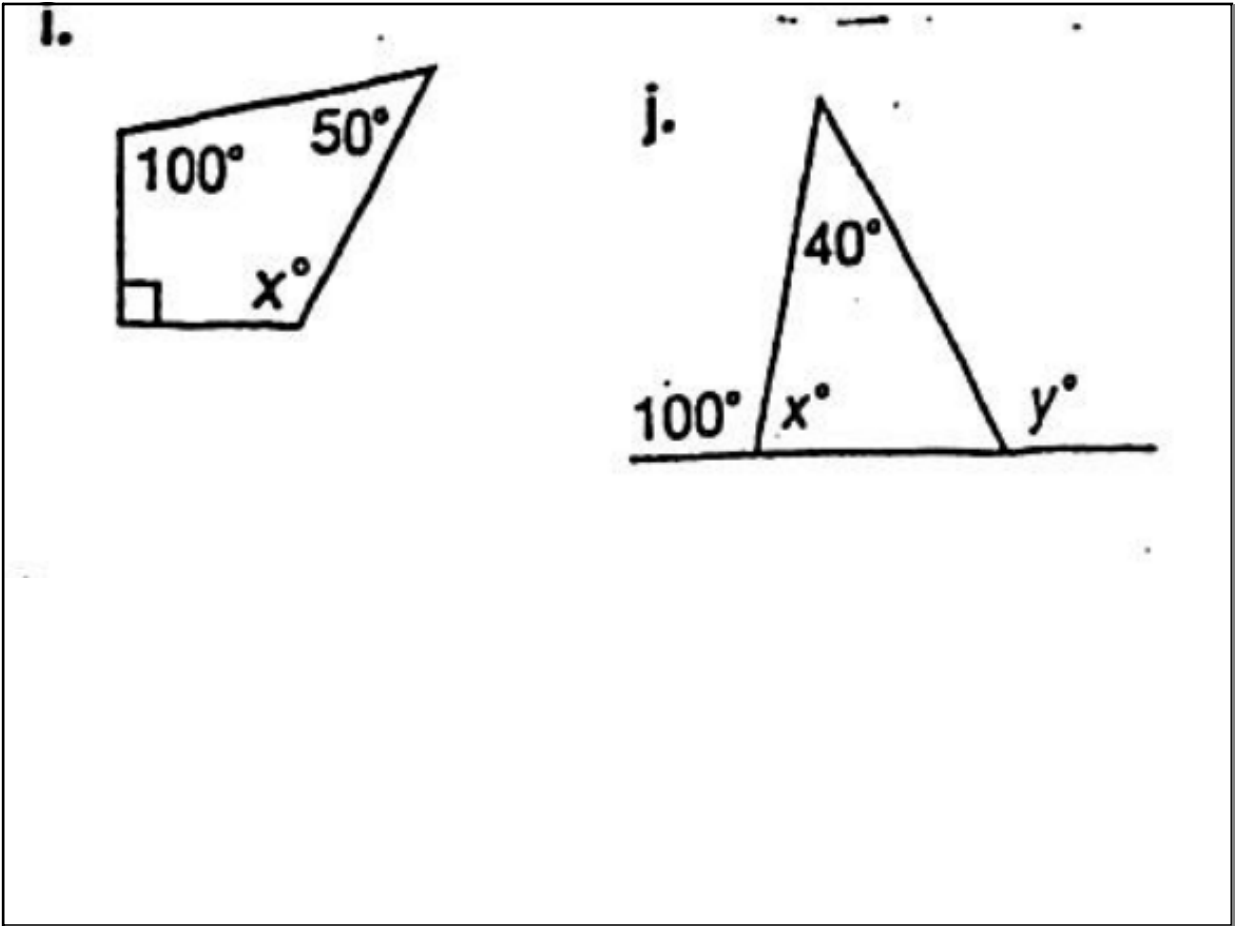

nov. 25-09:34

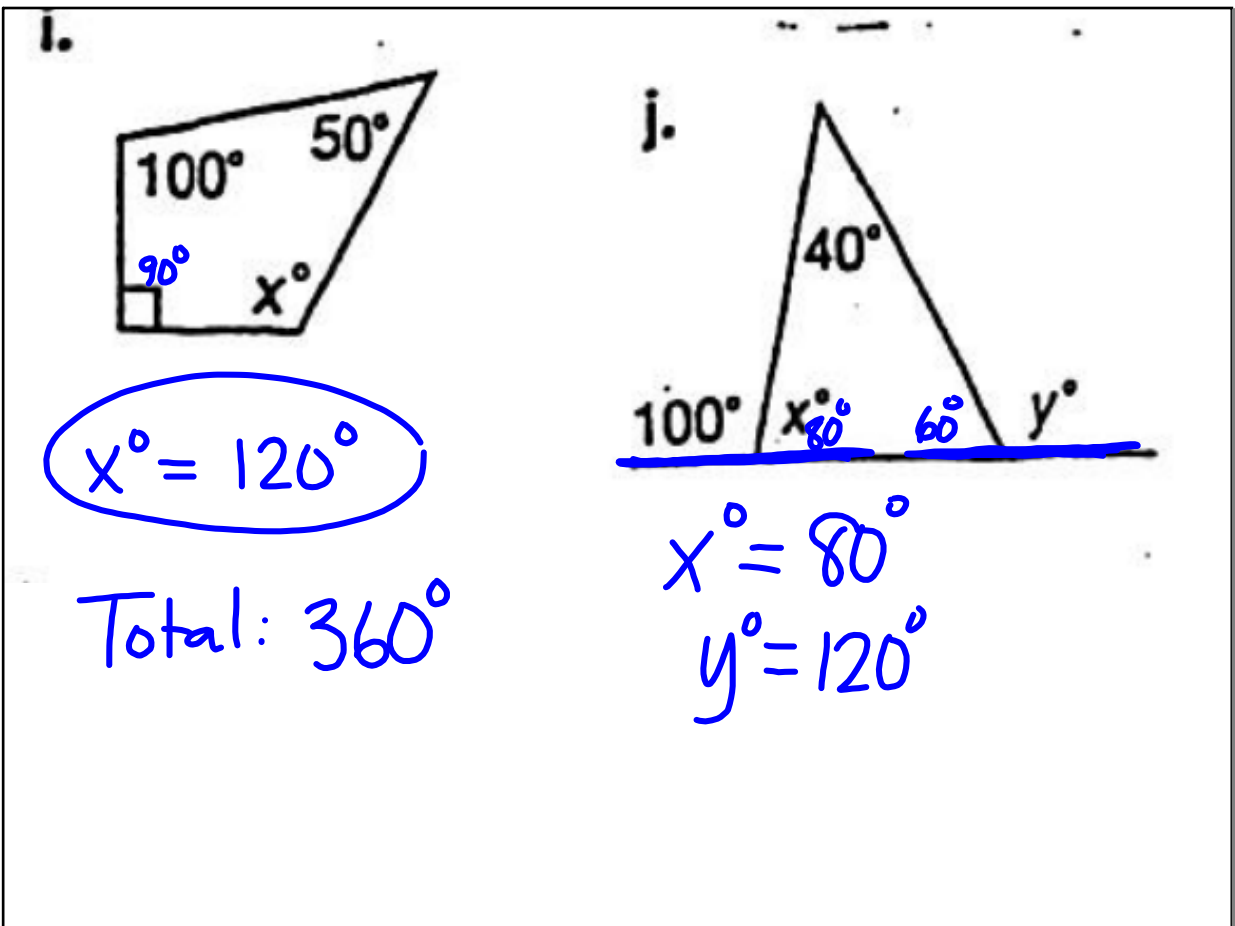

nov. 25-09:34

Question 5.

a) $x = 60^\circ$

b) $x = 50^\circ$

c) $x = 112^\circ$ et $y = 48^\circ$

d) $x = 110^\circ$

e) $x = 55^\circ$

f) $x = 120^\circ$

g) $x = 40^\circ$ et $y = 60^\circ$ et $z = 80^\circ$

h) $d = 95^\circ$

i) $x = 120^\circ$

j) $x = 80^\circ$ et $y = 120^\circ$

nov. 25-09:56