

**mathématiques 10e année**

**le jeudi 30 novembre 2023**

**Mme Barton**

mai 30-10:05

**Géométrie, Mesure, Finances 10**

**But: Géométrie - G5**

Démontrer sa compréhension des angles, y compris les angles aigus, droits, obtus, plats et réflexes en : dessinant, répliquant et construisant, divisant en deux parties égales et en résolvant des problèmes.

mai 31-08:43

**Géométrie, Mesure, Finances 10**

**But: Géométrie - G4**

Résoudre des problèmes portant  
sur des lignes parallèles,  
perpendiculaires et transversales  
et sur les paires d'angles formés  
entre elles.

mai 31-08:43

**Les angles  
et  
les droites**

mai 30-10:06

# Les angles et les droites

## Vocabulaire nécessaire

mai 30-10:06

La somme des angles  
d'un triangle est 180 degrés.





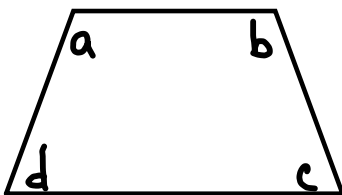

$$a + b + c = 180^\circ$$

La somme des angles  
d'un quadrilatère est 360 degrés.

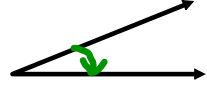

$$a + b + c + d = 360^\circ$$

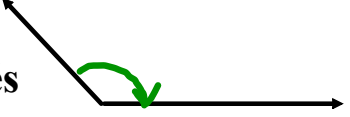
mai 28-16:26

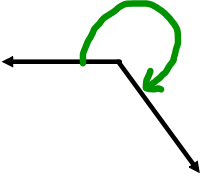
<u>Les angles</u>		
<u>Type d'angle</u>	<u>Mesure</u>	<u>Exemple</u>
angle aigu	entre 0 et 90 degrés	
angle droit	90 degrés	
angle obtus	entre 90 et 180 degrés	
angle plat	180 degrés	
angle rentrant (ou angle réflexe)	entre 180 et 360 degrés	

mai 23-12:20

Les angles

angles opposés

**les angles opposés sont toujours égaux**

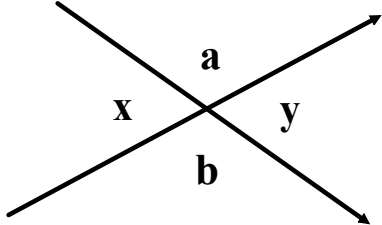

angle  $x = \text{angle } y$                       angle  $a = \text{angle } b$

mai 23-19:35

Les angles  
angles complémentaires

deux angles qui ont  
une somme de  $90^\circ$

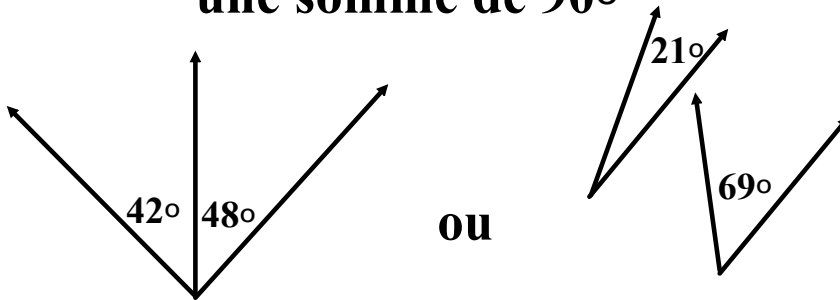

mai 23-19:45

Les angles  
angles supplémentaires

deux angles qui ont  
une somme de  $180^\circ$

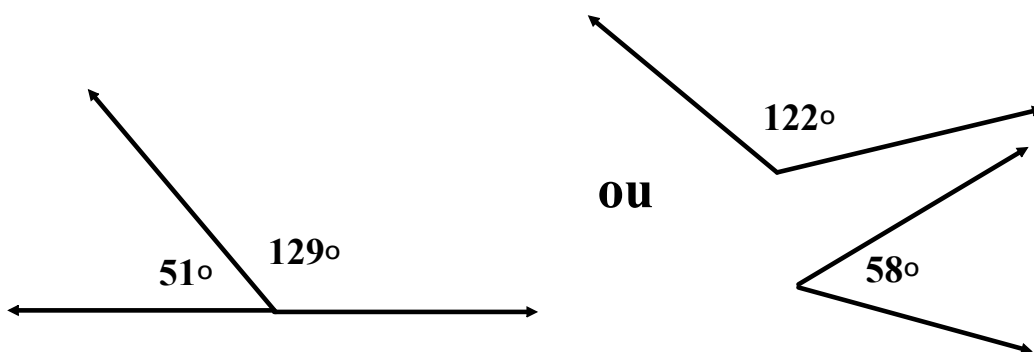

mai 23-19:51

# Questions de Révision

Sors une nouvelle feuille de papier.

Ferme le reste!

nov. 28-14:56

**#1**

$x^\circ$   $130^\circ$   $y^\circ$

$x^\circ =$  \_\_\_\_\_

$y^\circ =$  \_\_\_\_\_

**#2**

$x^\circ$   $x^\circ$   $40^\circ$

$x^\circ =$  \_\_\_\_\_

nov. 28-14:48

<p style="text-align: right;">#1</p> <p><math>x^\circ = \underline{50^\circ}</math> <math>y^\circ = \underline{40^\circ}</math></p>	<p style="text-align: right;">#2</p> <p><math>x^\circ = \underline{25^\circ}</math> complémentaires</p>
---	---

nov. 28-14:48

<p style="text-align: right;">#3</p> <p><math>x^\circ = \underline{\quad}</math> <math>y^\circ = \underline{\quad}</math></p>	<p style="text-align: right;">#4</p> <p><math>x^\circ = \underline{\quad}</math> <math>y^\circ = \underline{\quad}</math></p>
---	---

nov. 28-14:48

#3

$x^\circ = \underline{58^\circ}$   
 $y^\circ = \underline{61^\circ}$   
opposés

nov. 28-14:48

#4

$x^\circ = \underline{138^\circ}$   
 $y^\circ = \underline{42^\circ}$

#5

$x^\circ = \underline{\quad}$   
 $y^\circ = \underline{\quad}$   
 $z^\circ = \underline{\quad}$

nov. 28-14:48

#6

$x^\circ = \underline{\quad}$



#5

$x^\circ = \underline{122^\circ}$   
 $y^\circ = \underline{58^\circ}$   
 $z^\circ = \underline{122^\circ}$

#6

$x^\circ = \underline{30^\circ}$

nov. 28-14:48

#7

$x^\circ = \underline{\hspace{2cm}}$

#8

$x^\circ = \underline{\hspace{2cm}}$   
 $y^\circ = \underline{\hspace{2cm}}$

nov. 28-14:52

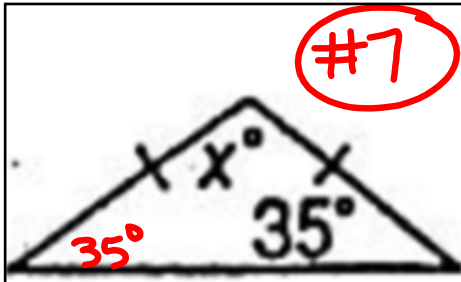

$$x^\circ = \underline{110^\circ}$$

$$35^\circ + 35^\circ = 70^\circ$$

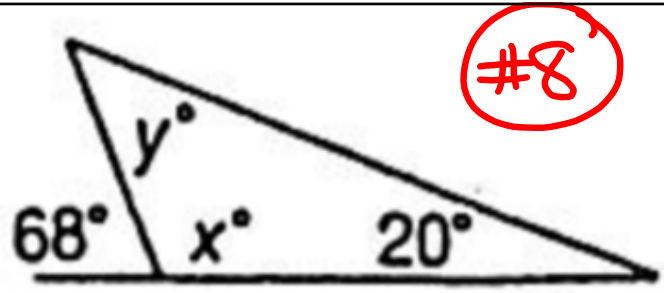

$$x^\circ = \underline{112^\circ}$$

$$y^\circ = \underline{48^\circ}$$

$$180^\circ - 132^\circ = 48^\circ$$

nov. 28-14:52

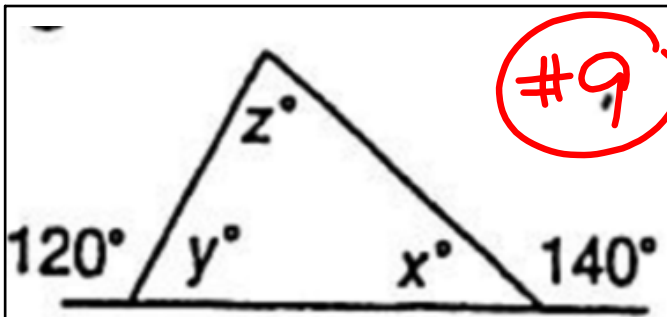

$$x^\circ = \underline{\hspace{2cm}}$$

$$y^\circ = \underline{\hspace{2cm}}$$

$$z^\circ = \underline{\hspace{2cm}}$$

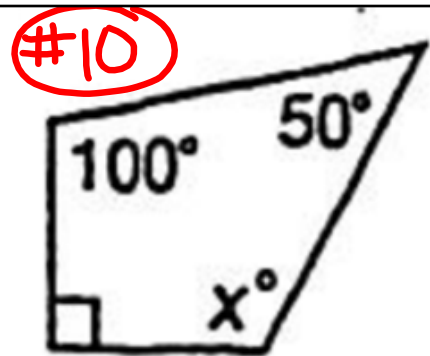

$$x^\circ = \underline{\hspace{2cm}}$$

nov. 28-14:53

#9

$x^\circ = \underline{40^\circ}$   
 $y^\circ = \underline{60^\circ}$   
 $z^\circ = \underline{80^\circ}$

#10

$90^\circ$   
 $360^\circ - 240^\circ = 120^\circ$   
 $x^\circ = \underline{120^\circ}$

nov. 28-14:53

## Les droites perpendiculaires

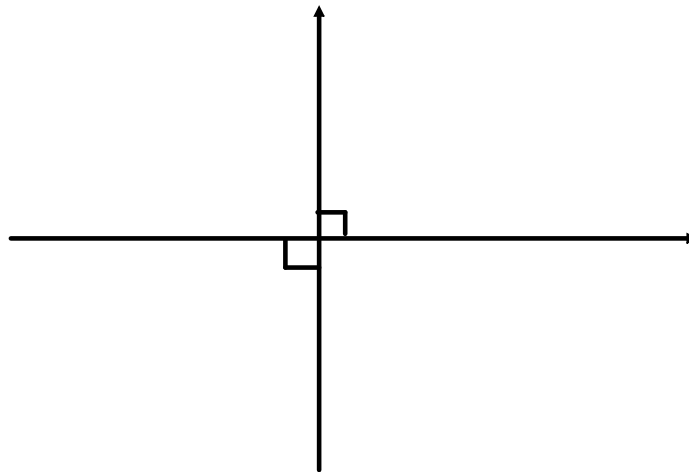

(droites qui se coupent aux angles droits)

mai 29-20:12

# Les droites parallèles

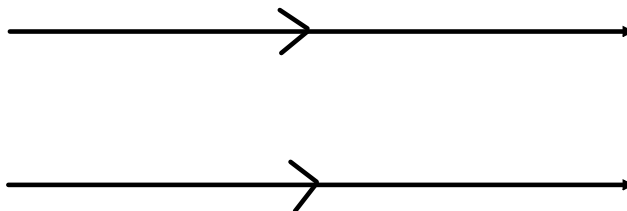

mai 29-20:13

## une sécante

une droite qui coupe deux droites parallèles

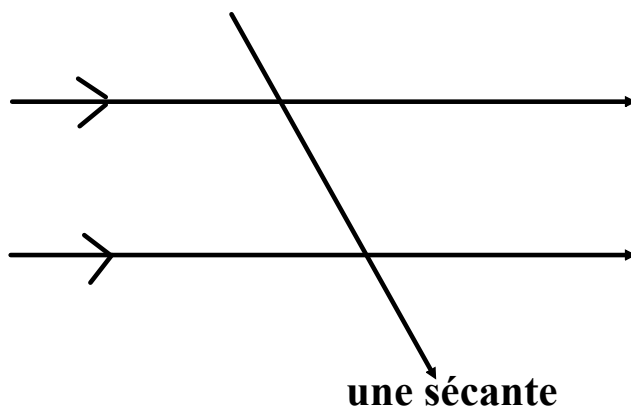

mai 29-20:13

Les angles

angles co-internes

angles qui forment un crochet (C) quand une sécante coupe les droites parallèles

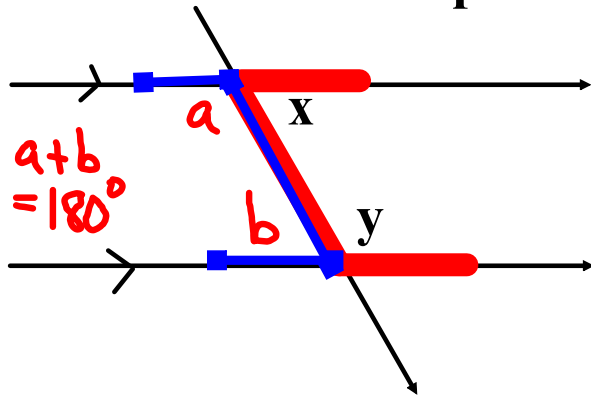

$x + y = \underline{180^\circ}$

les angles co-internes ont une somme de  $180^\circ$

mai 23-20:09

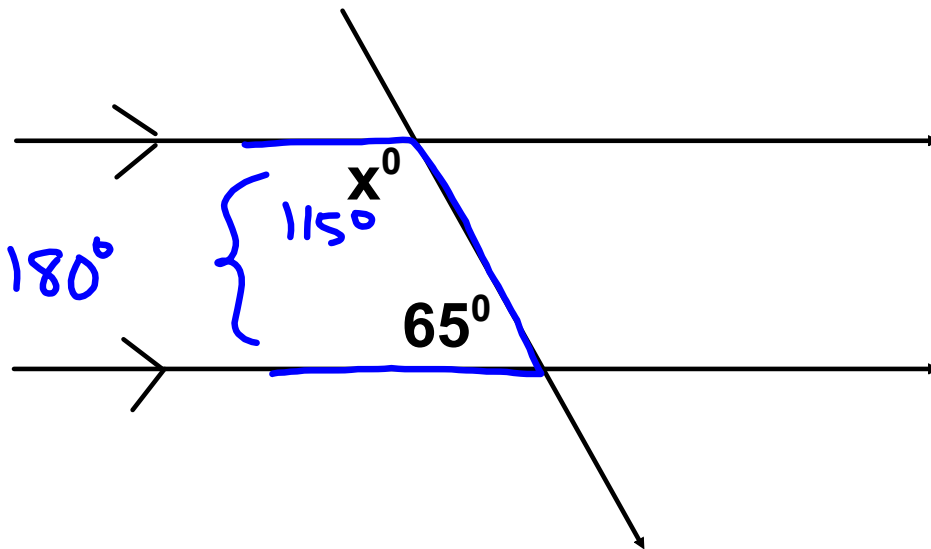

mai 29-20:07

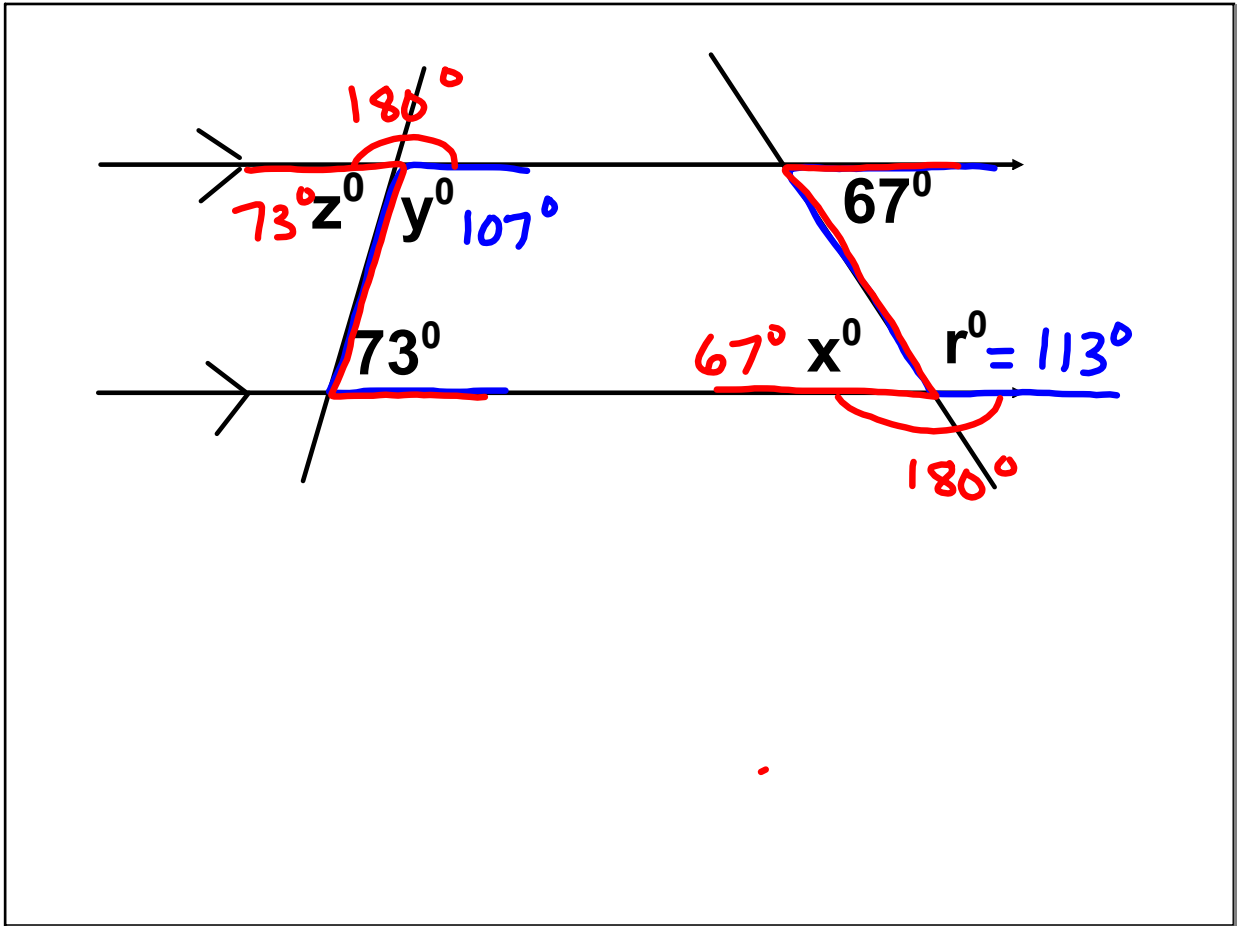

mai 29-20:07

Les angles

angles alternes internes

angles qui forment un "Z" quand une sécante coupe les droites parallèles

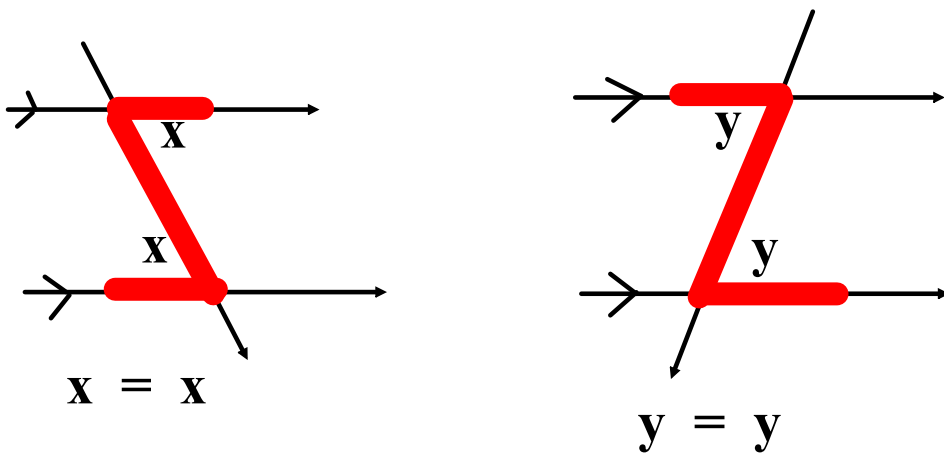

les angles alternes internes sont toujours égaux

mai 23-20:18

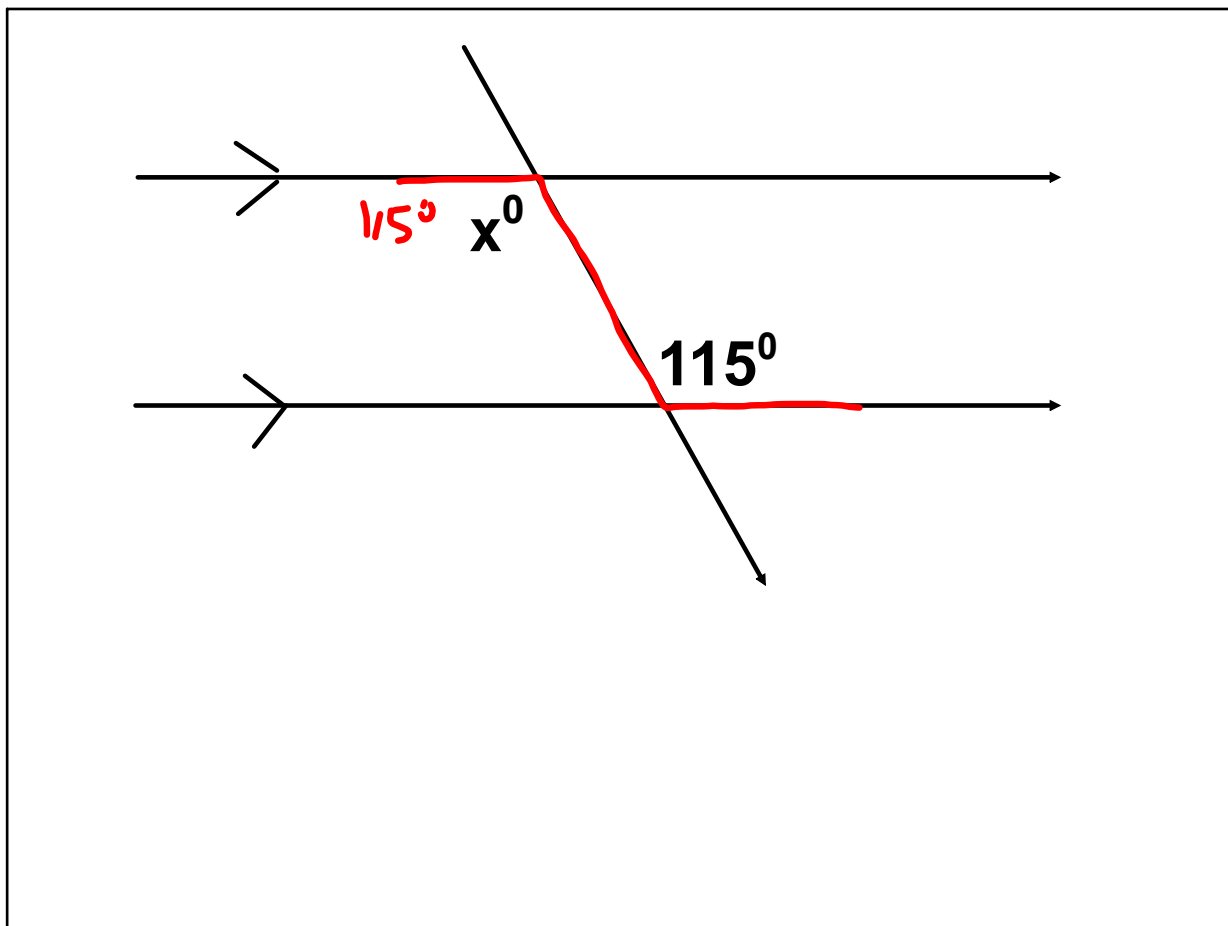

mai 29-20:08

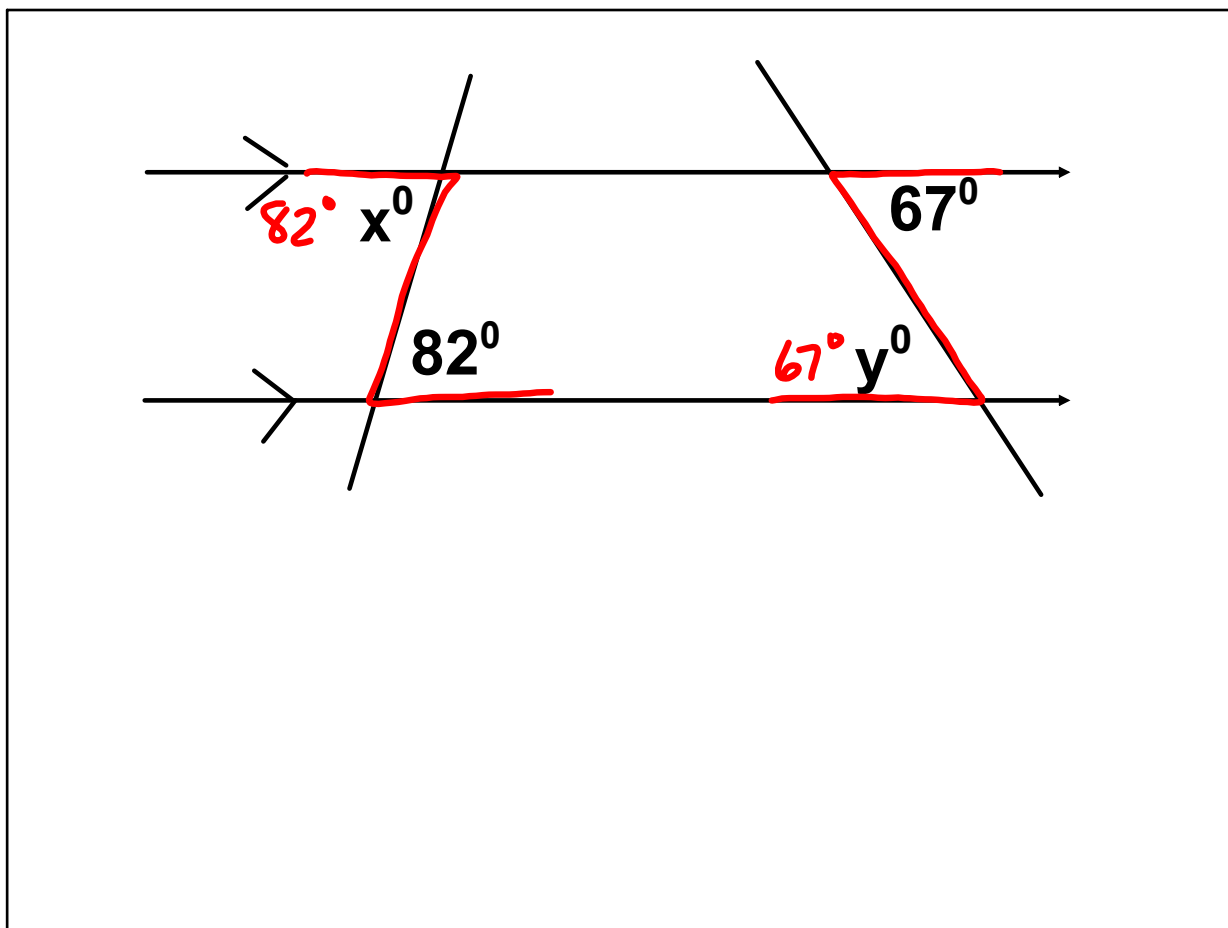

mai 29-20:08

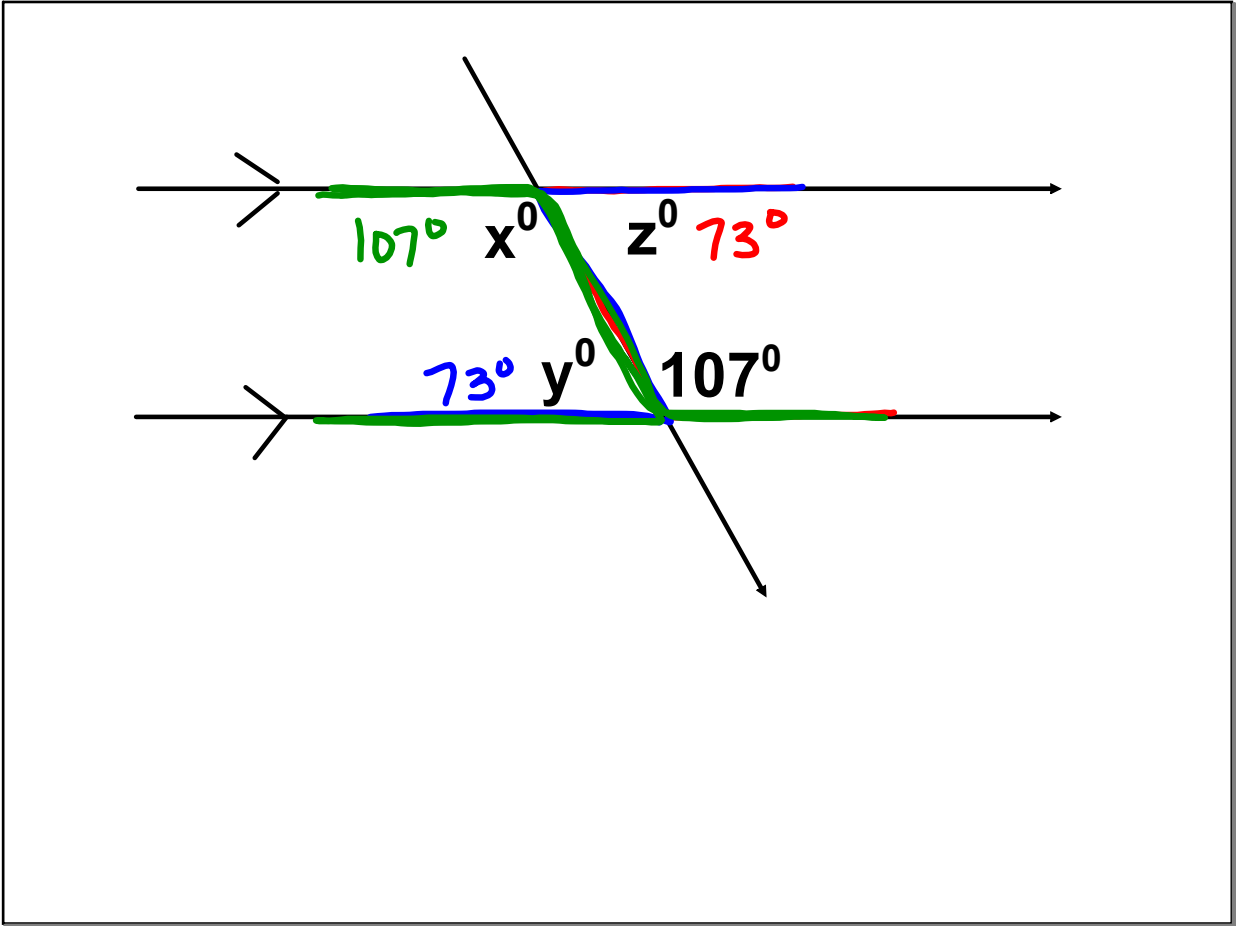

mai 29-20:08

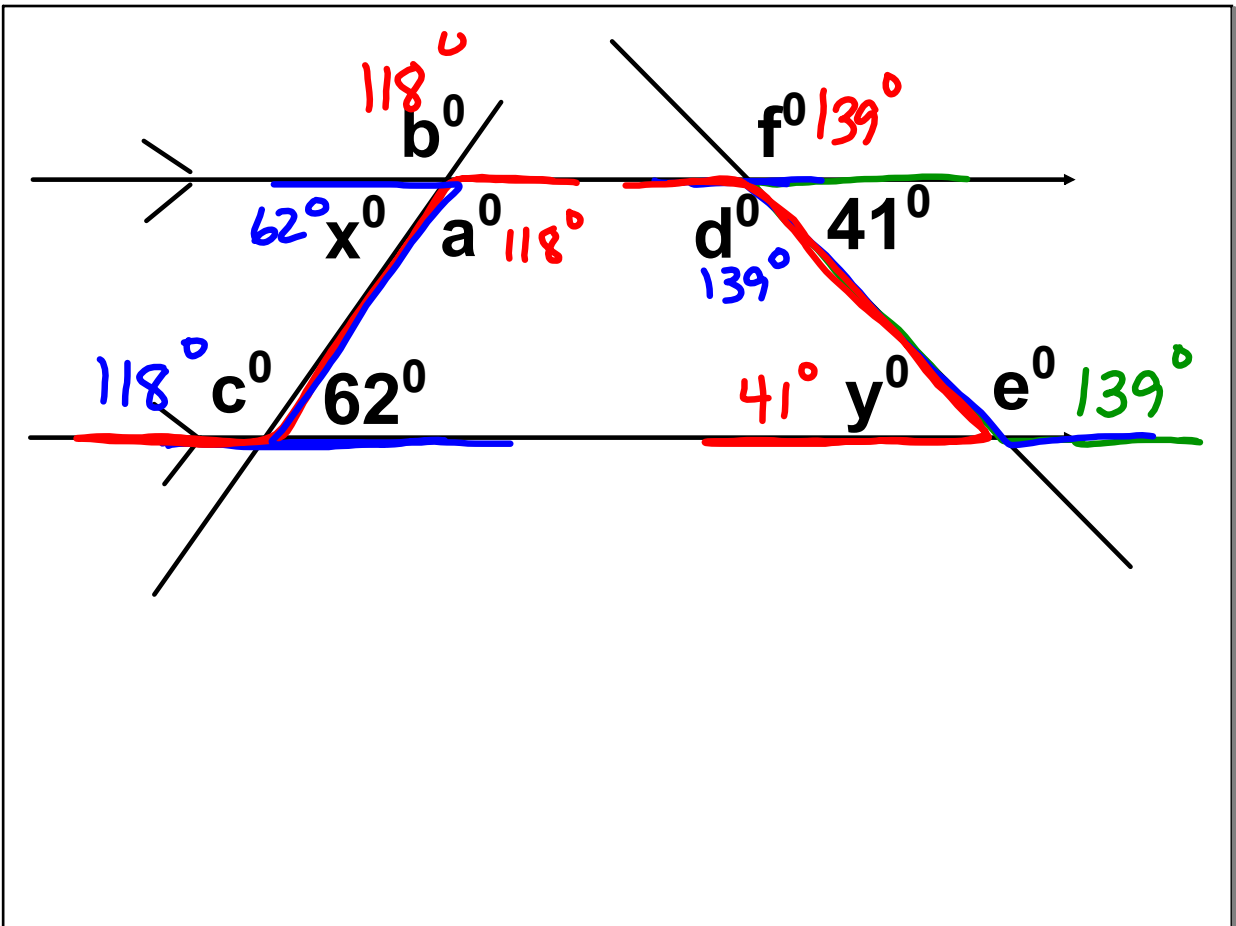

mai 29-20:08



# Les angles

## angles correspondants

angles qui forment un "F" quand une sécante coupe les droites parallèles

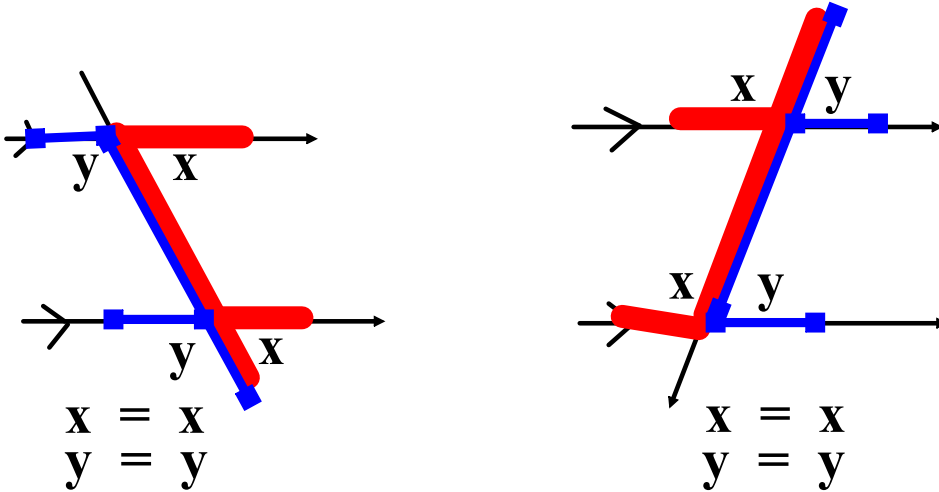

les angles correspondants sont toujours égaux

mai 23-20:25

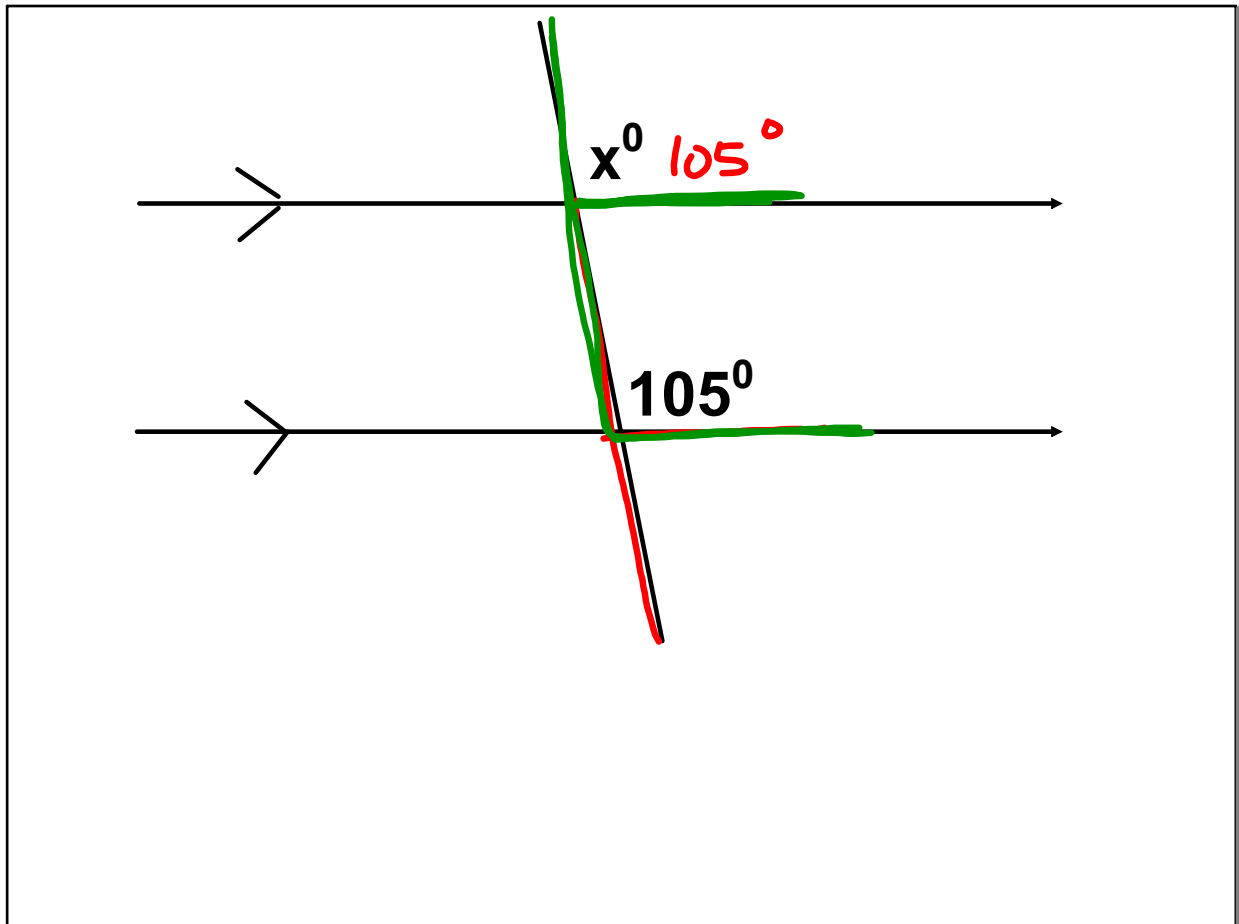

mai 29-20:08

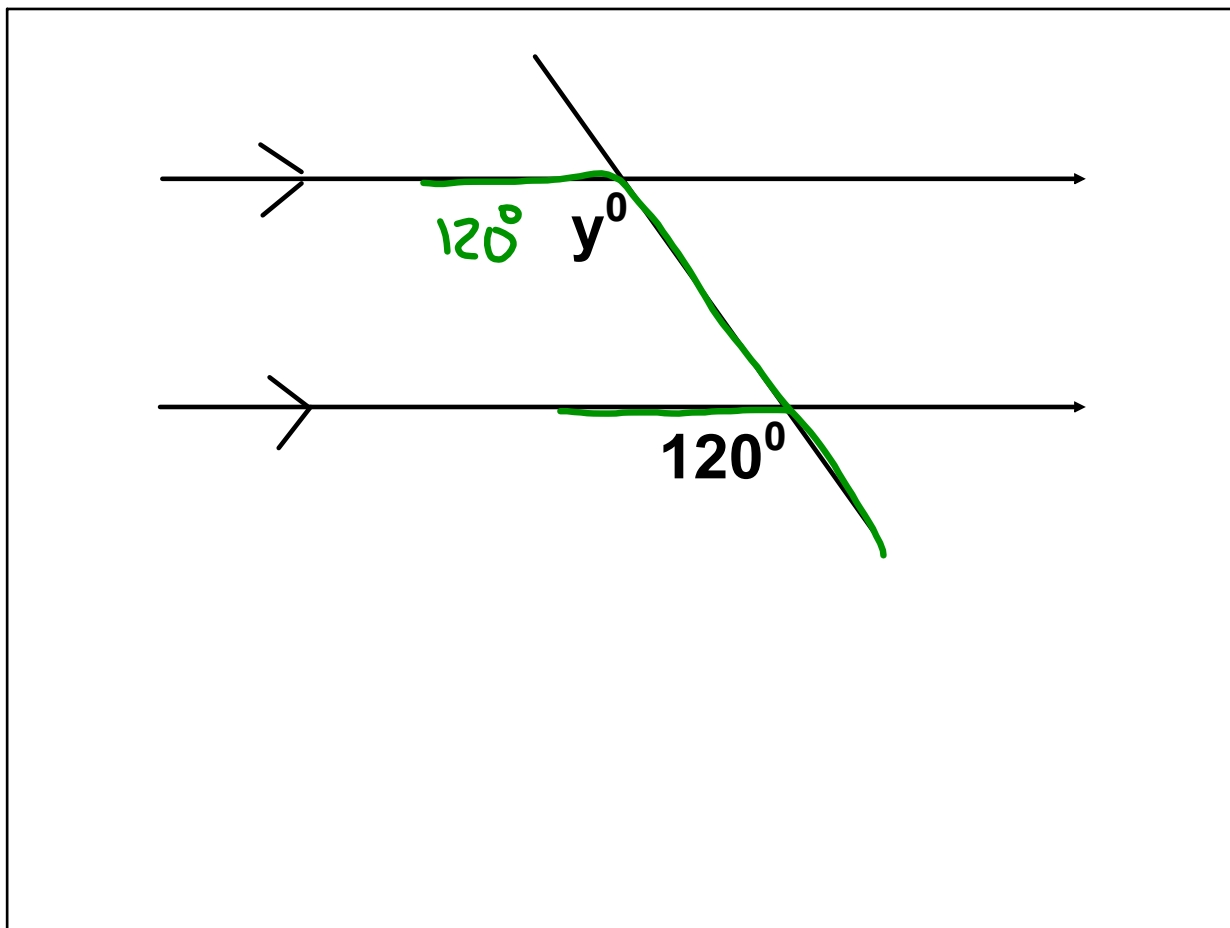

mai 29-20:09

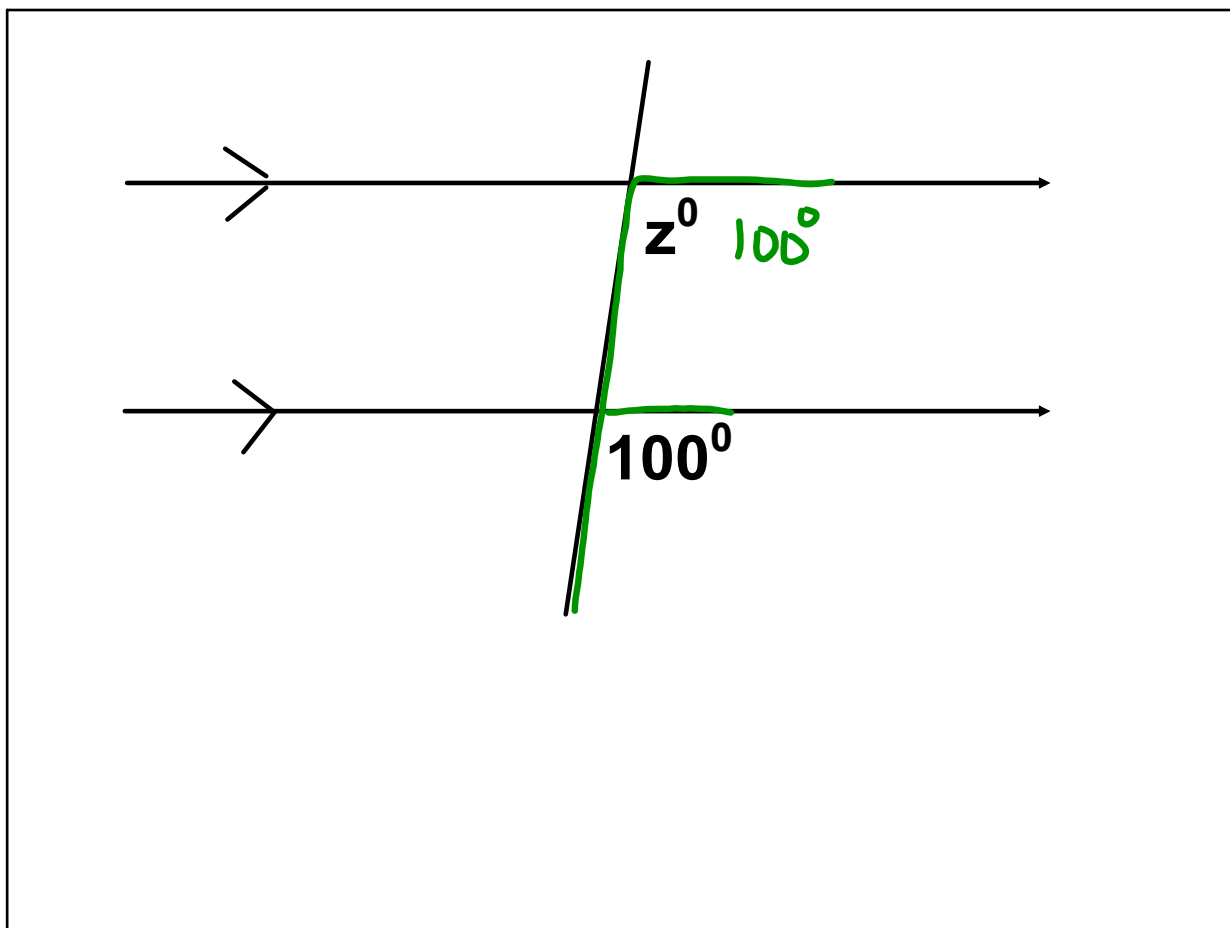

mai 29-20:09

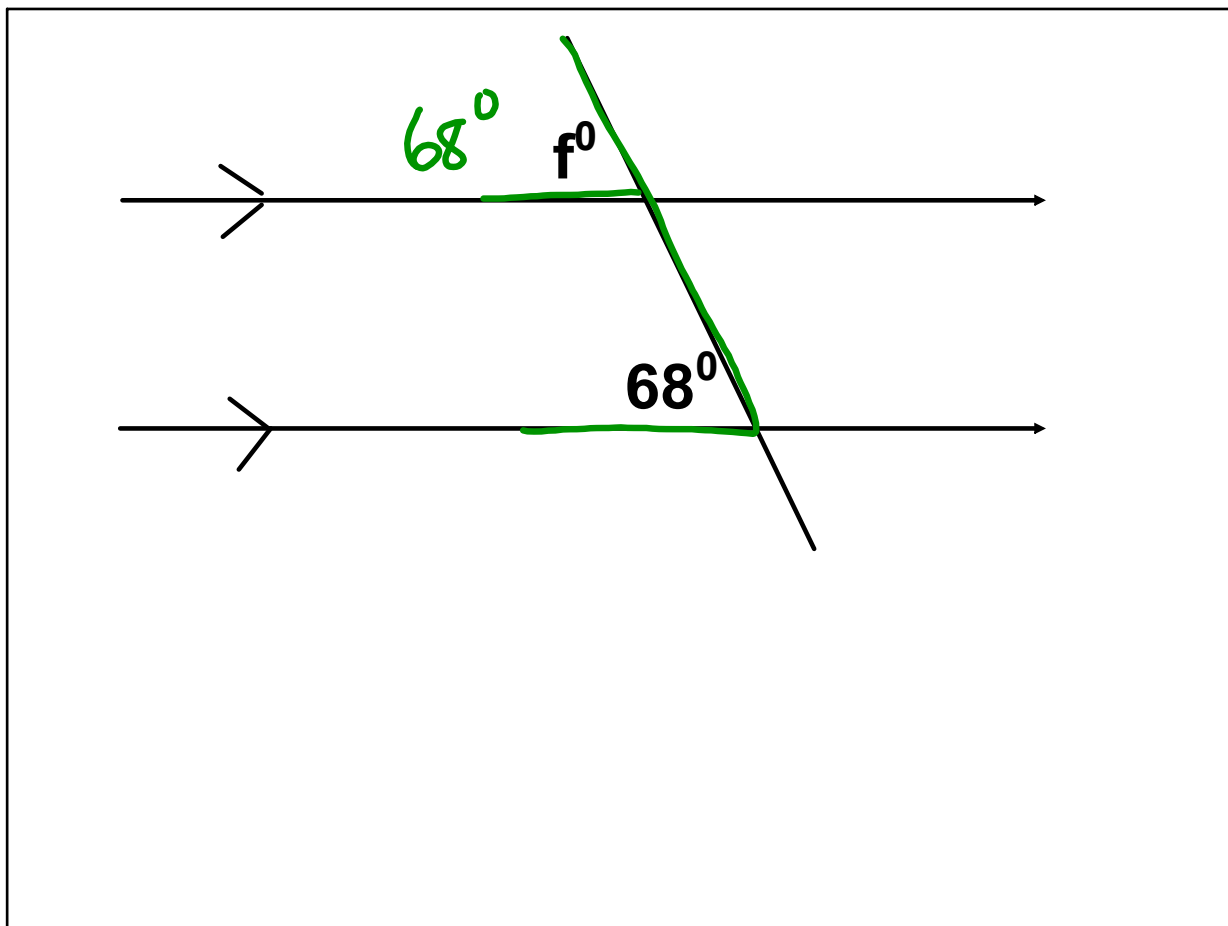

mai 29-20:09

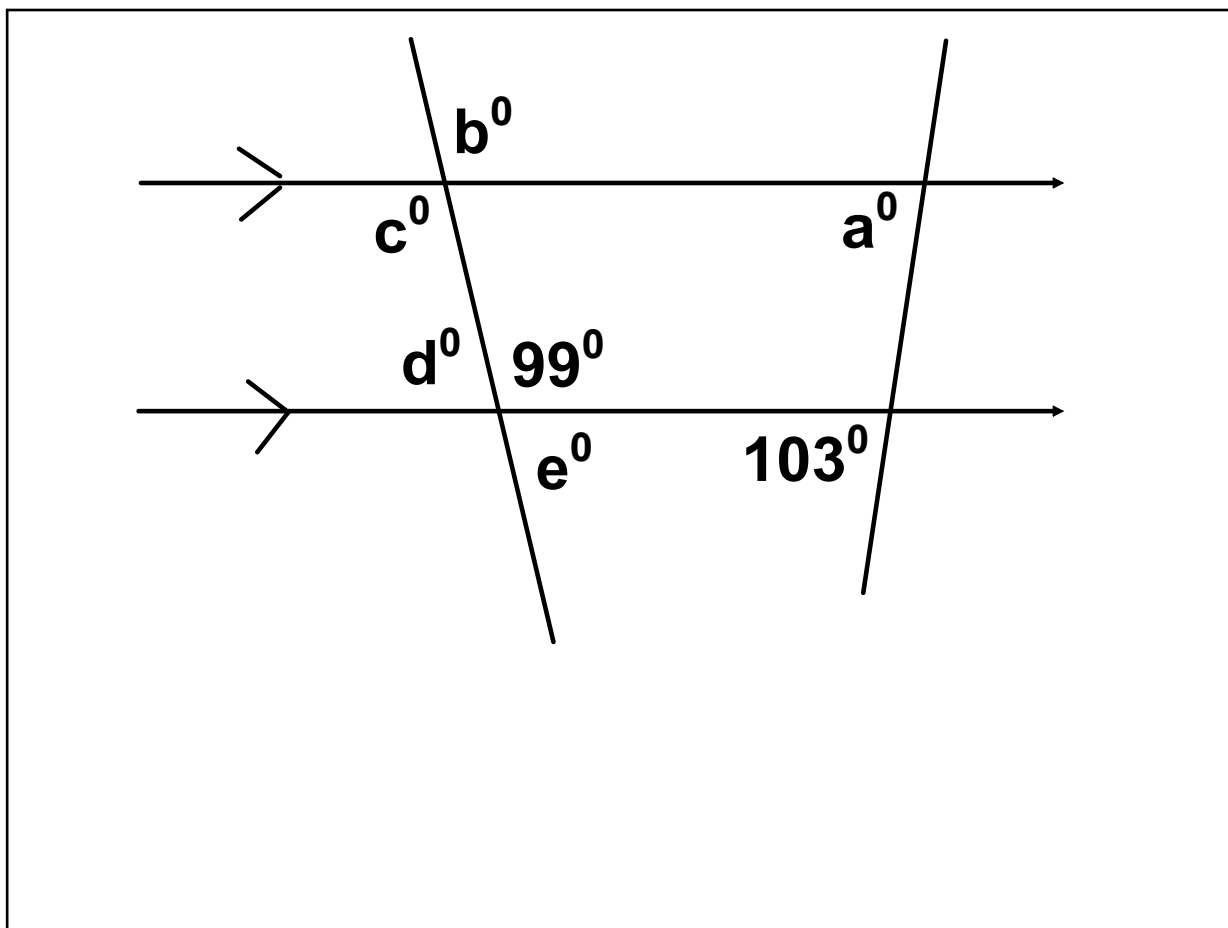

mai 29-20:09

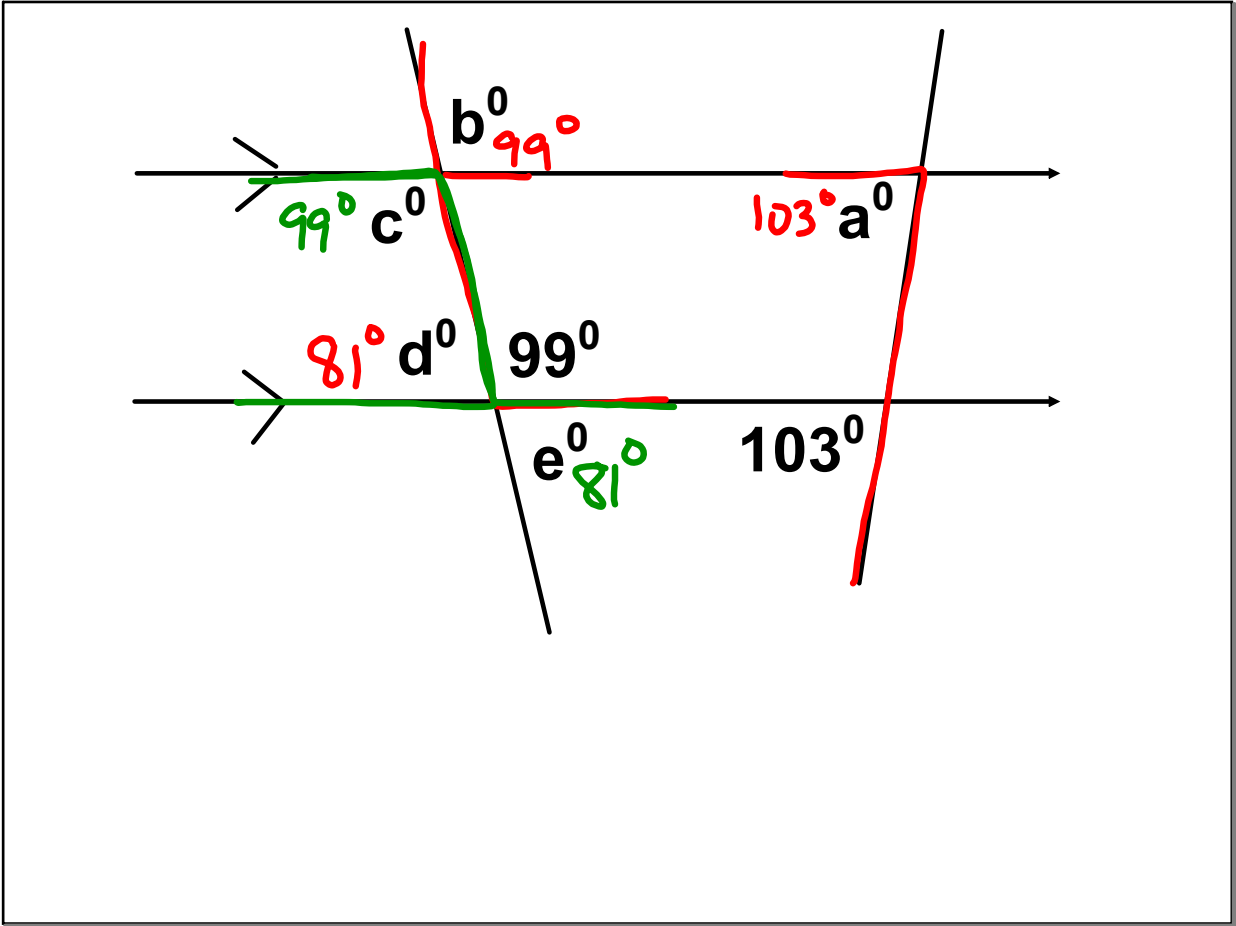

mai 29-20:09

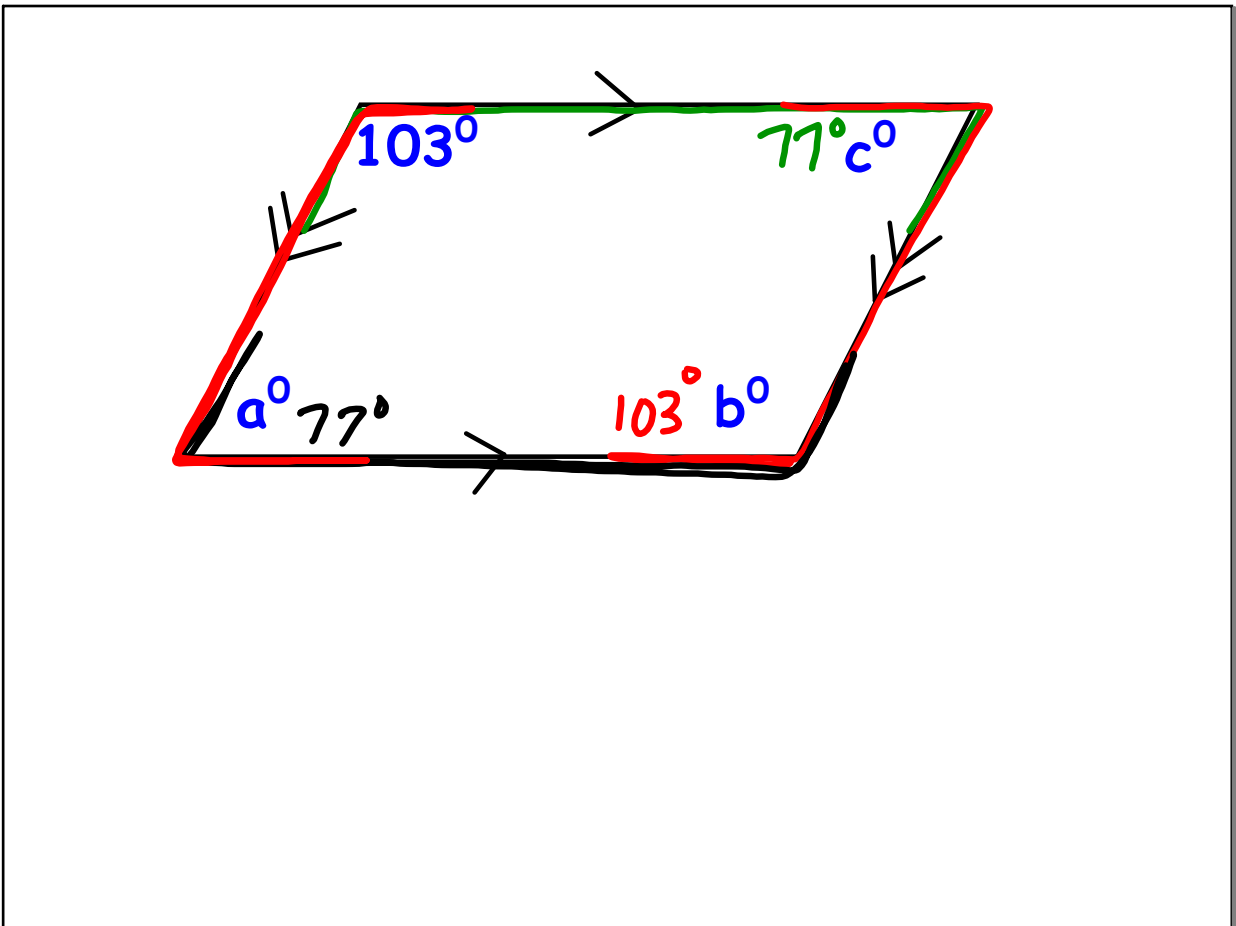

mai 29-20:14

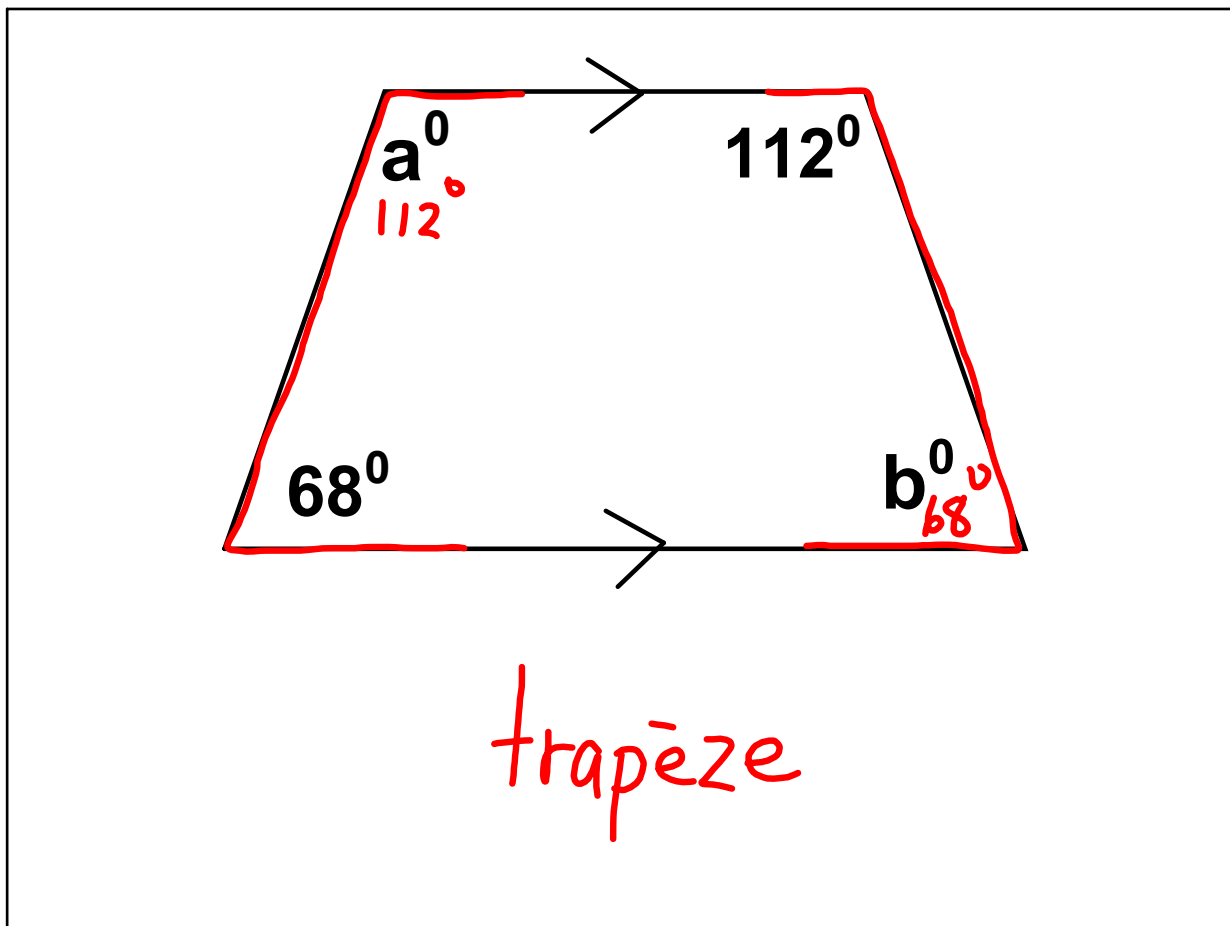

mai 29-20:14

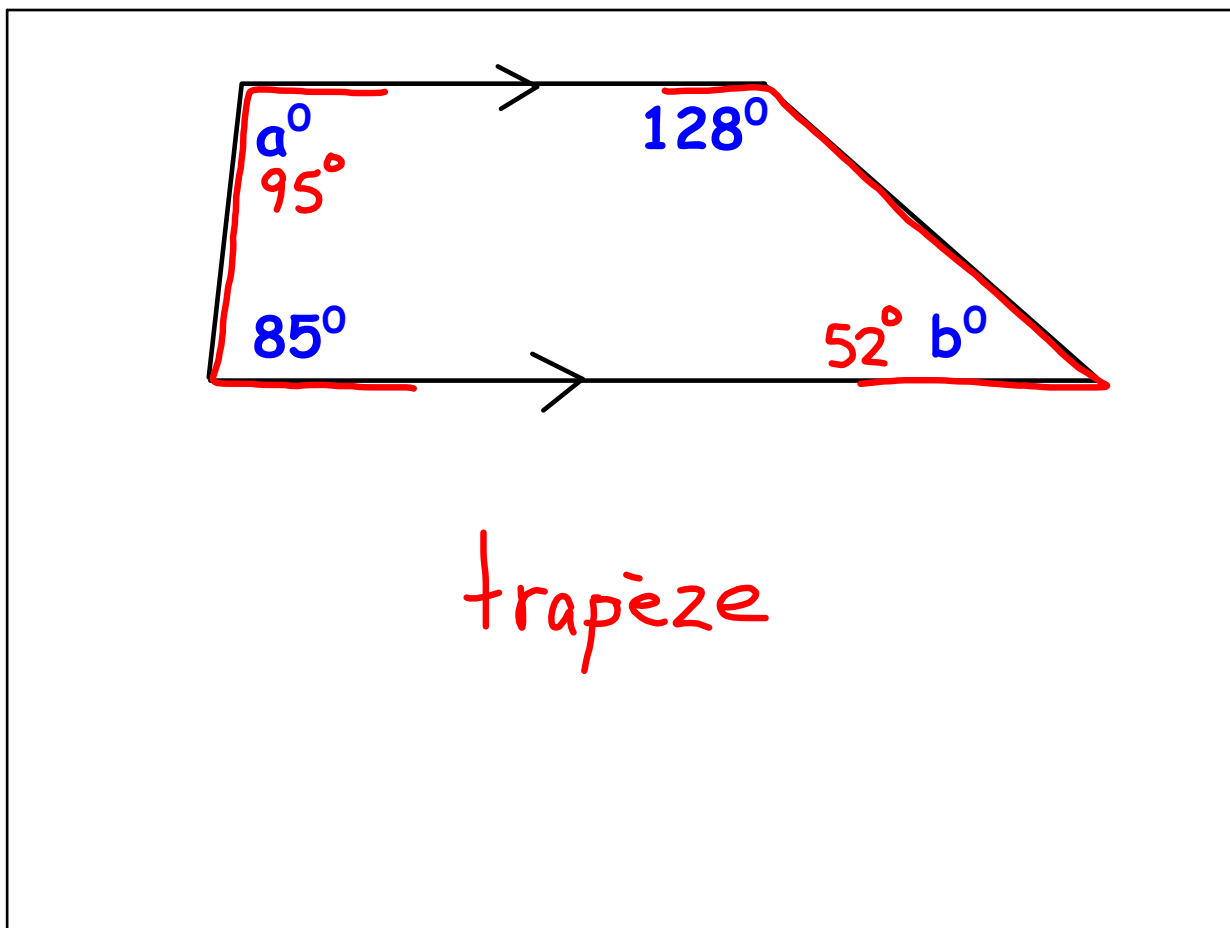

mai 29-20:15

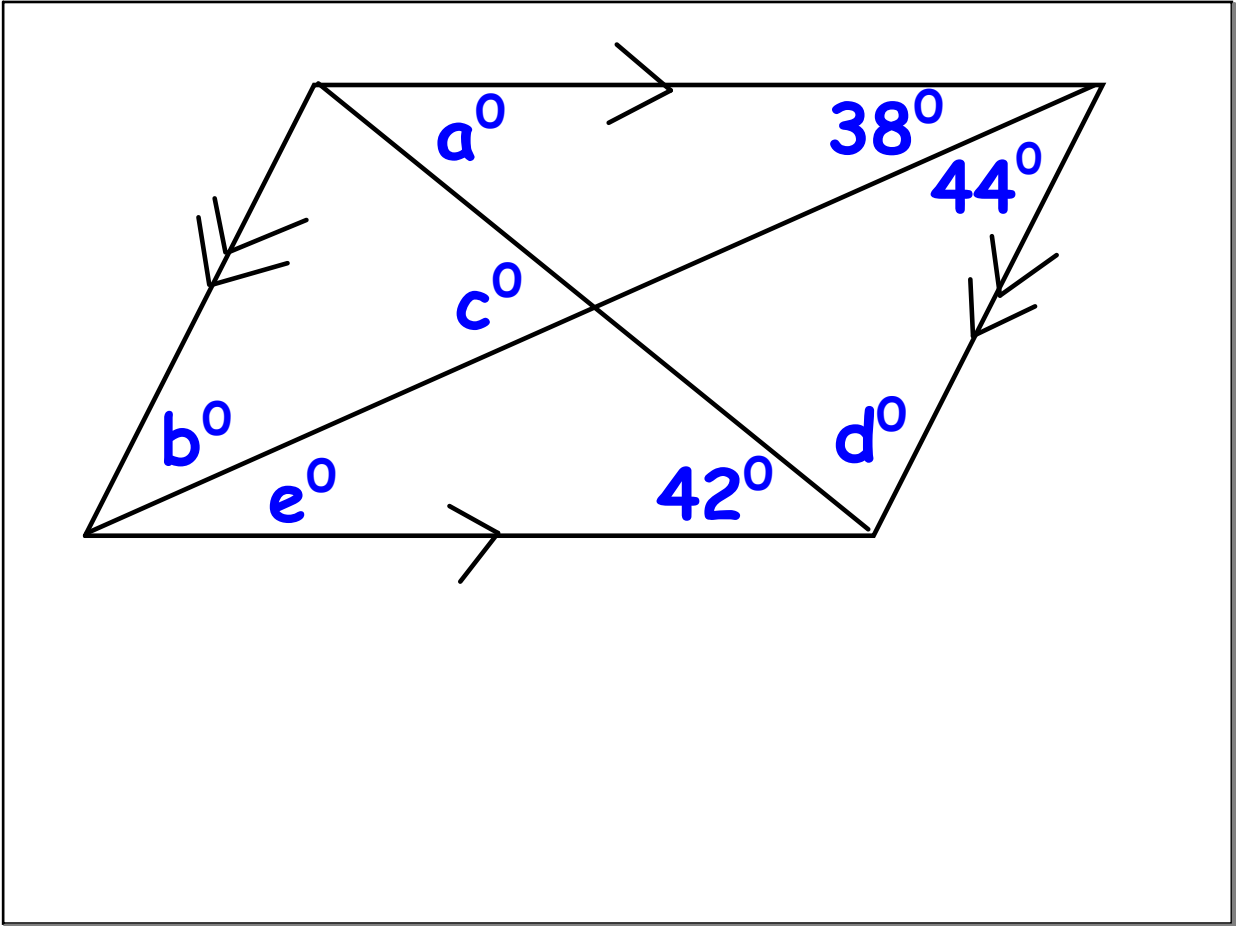

mai 29-20:15

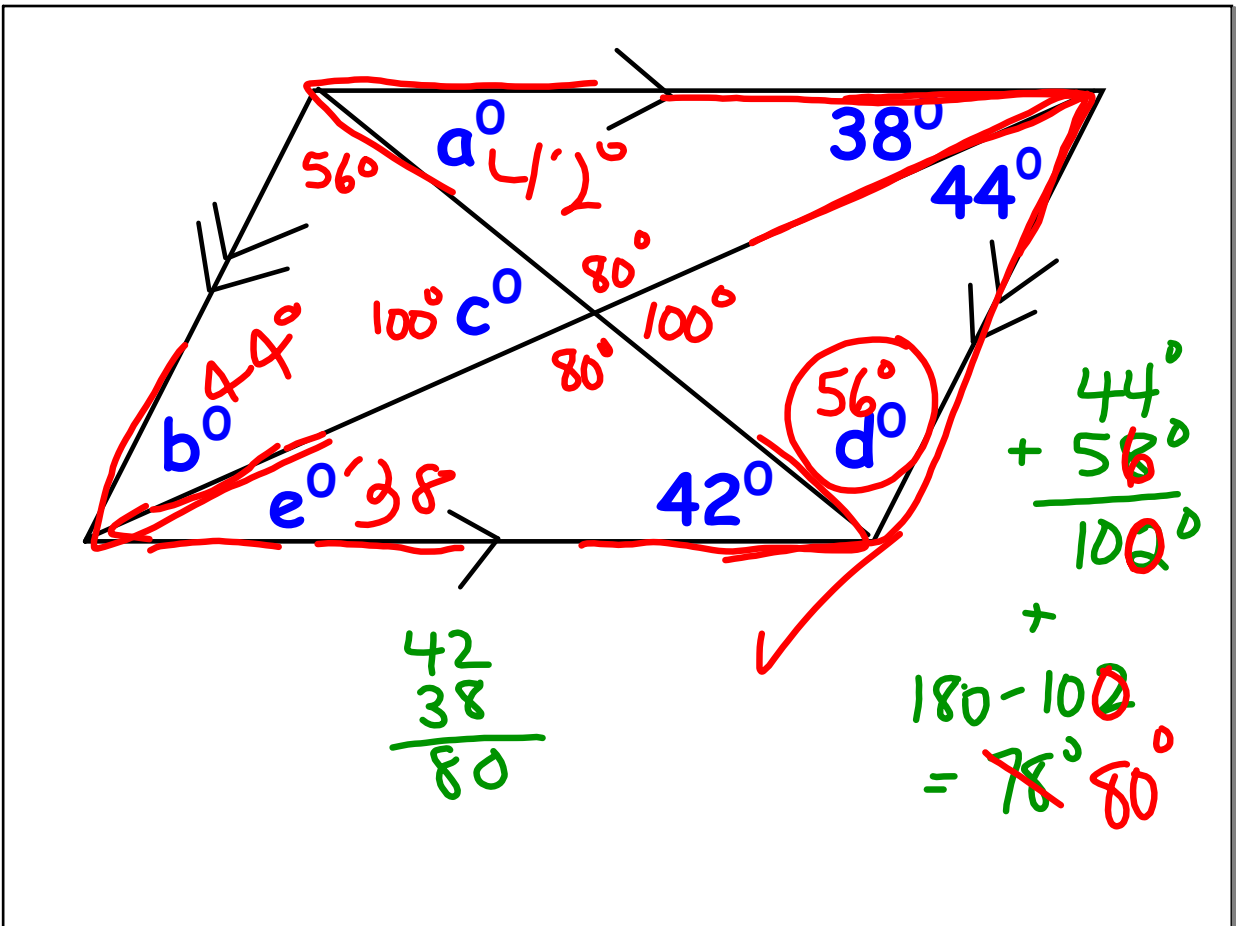

mai 29-20:15

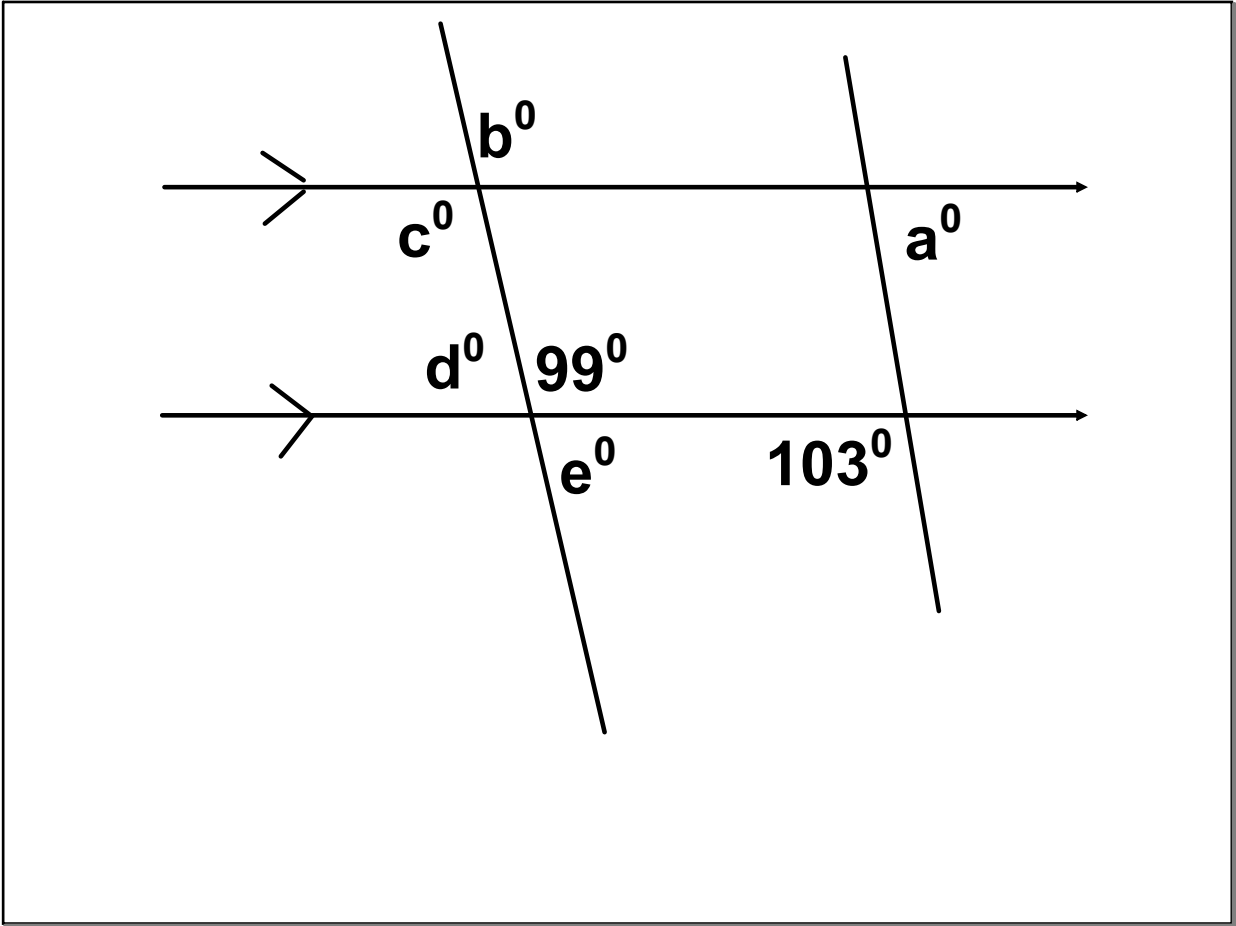

mai 29-20:15

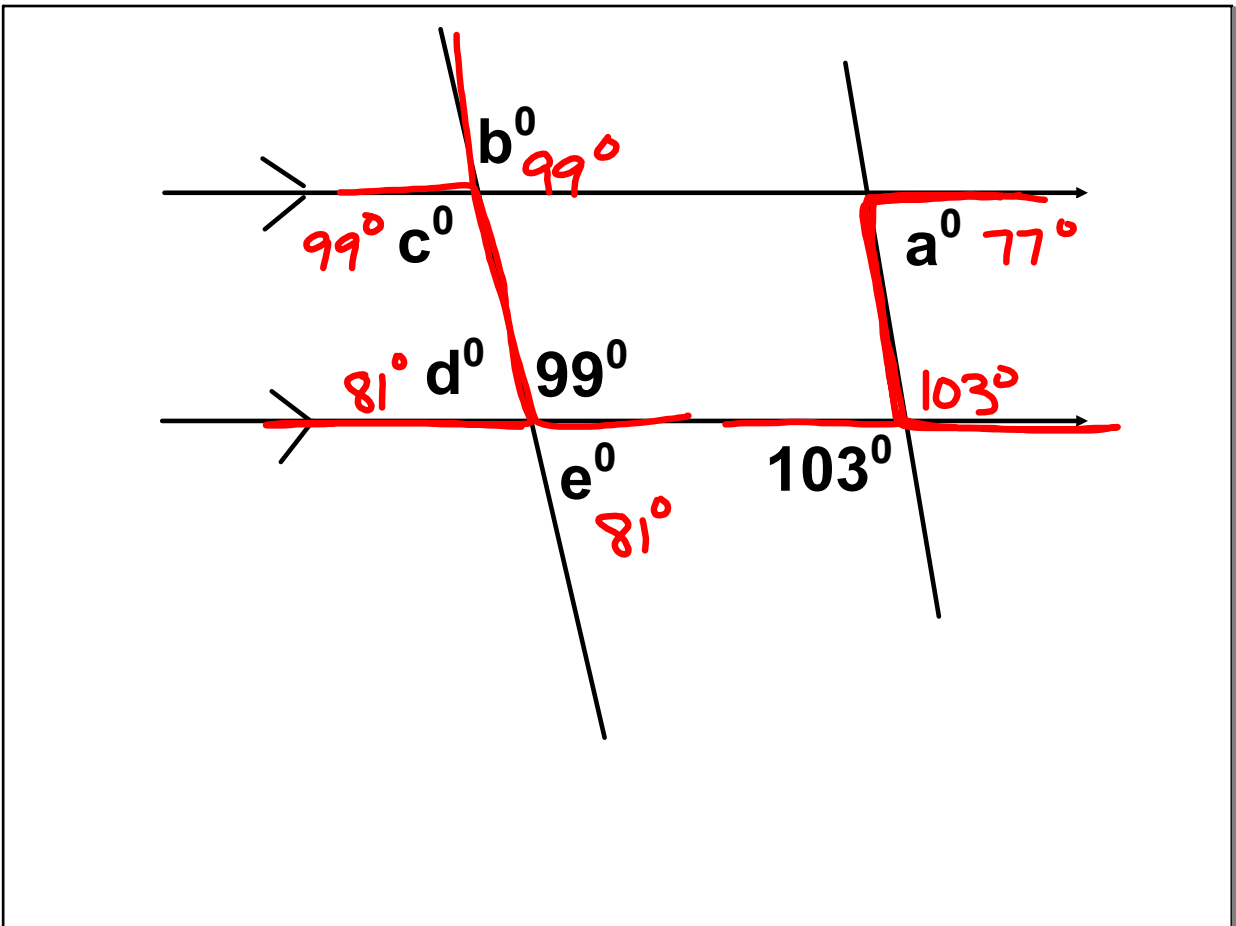

mai 29-20:15

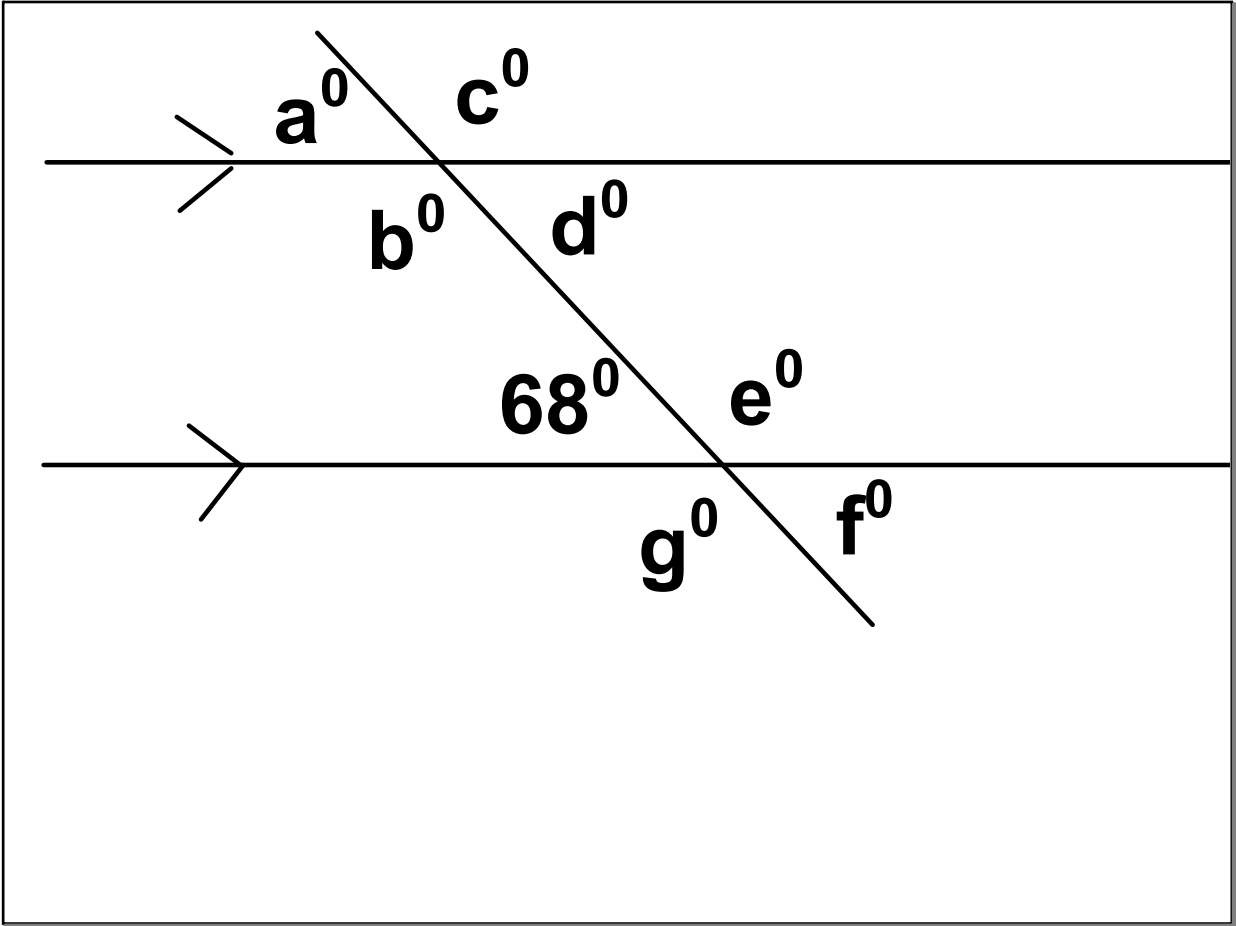

mai 29-20:15

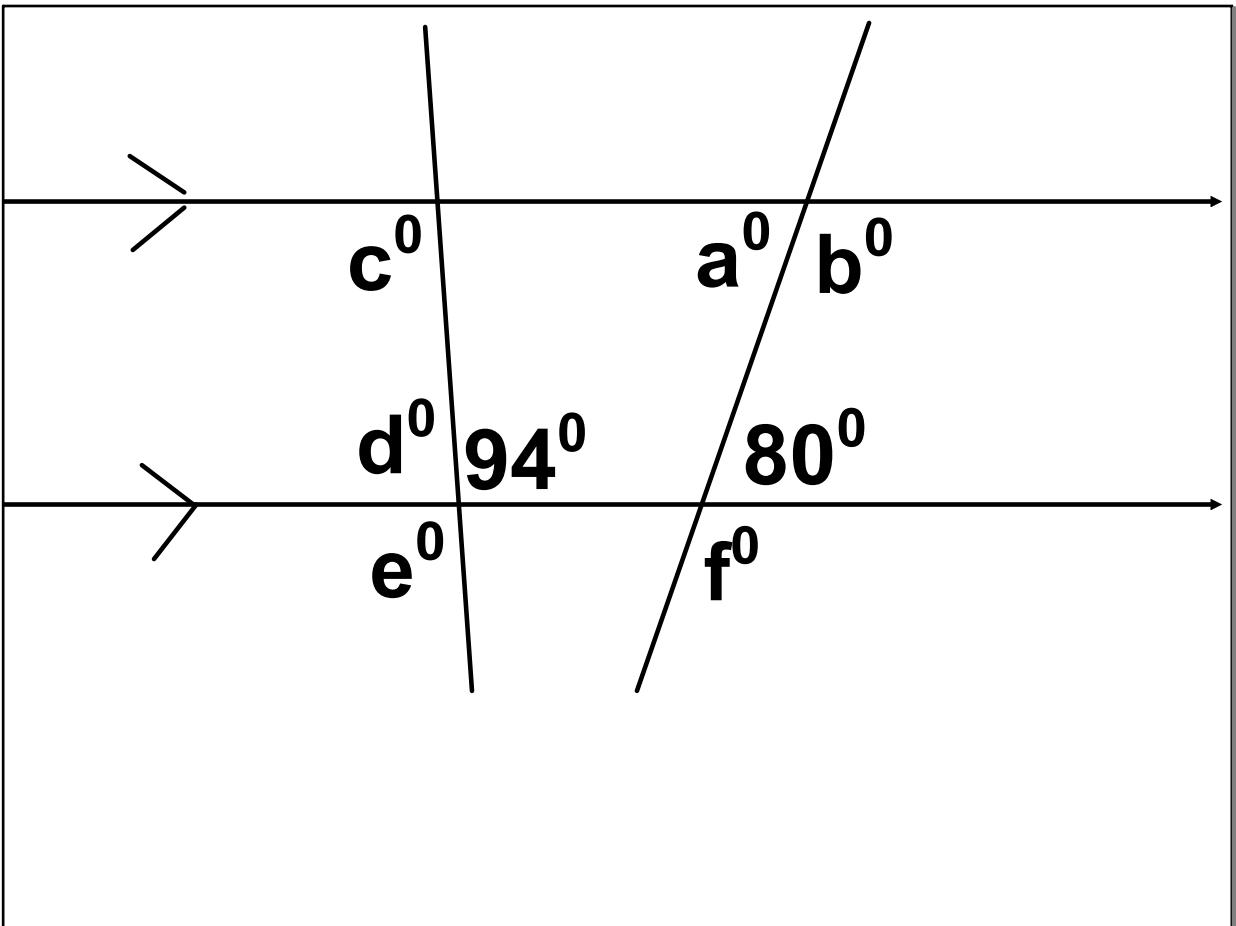

mai 29-20:16



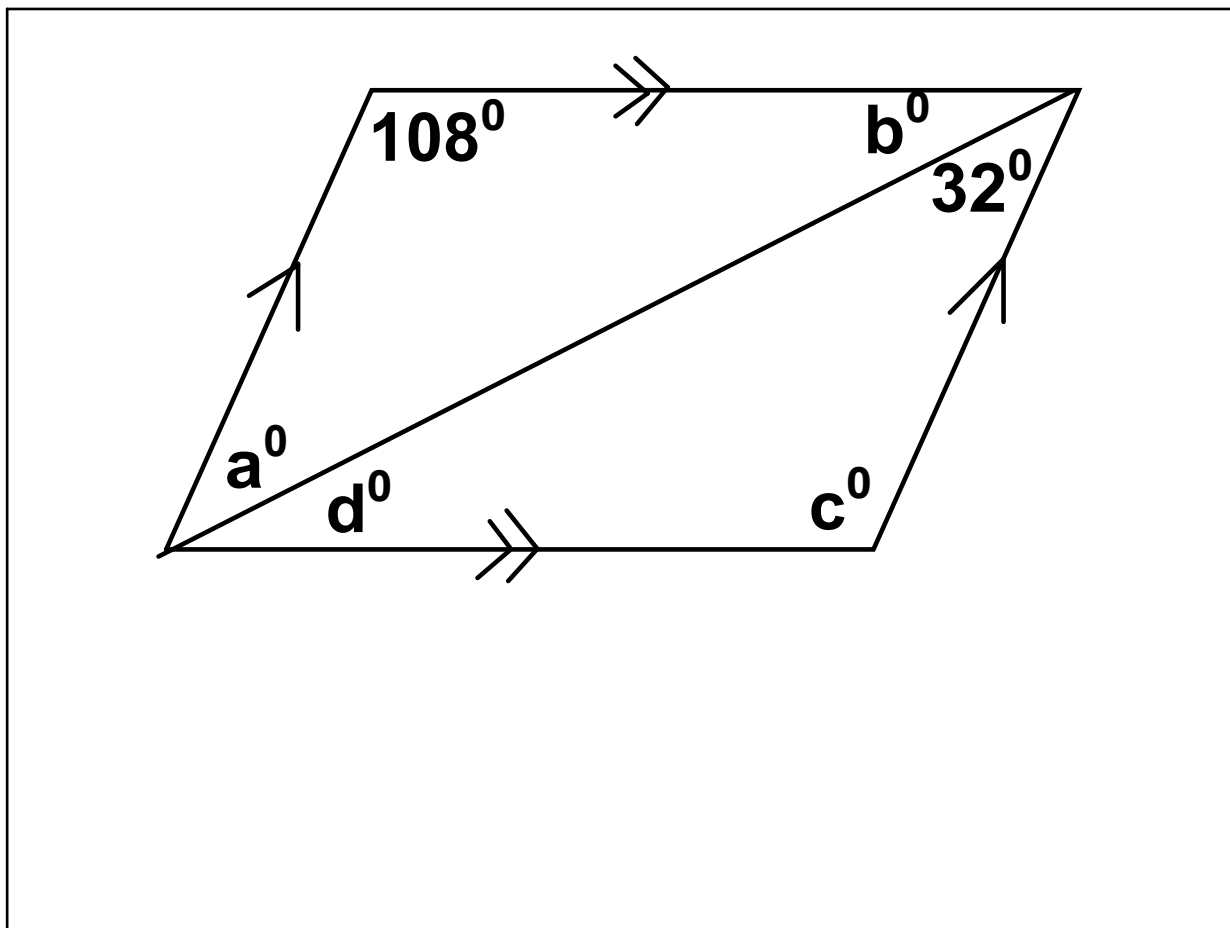

mai 29-20:16

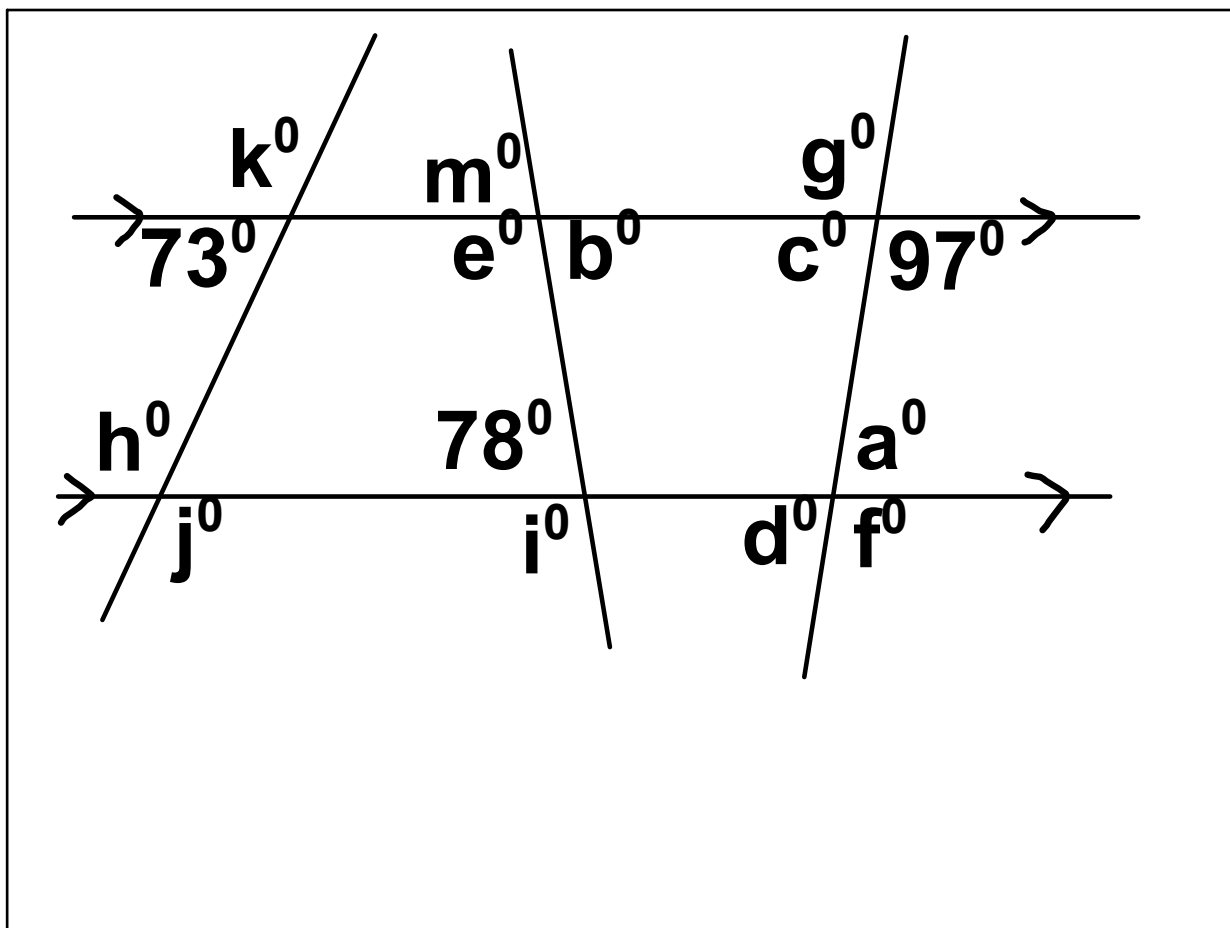

nov. 28-15:05

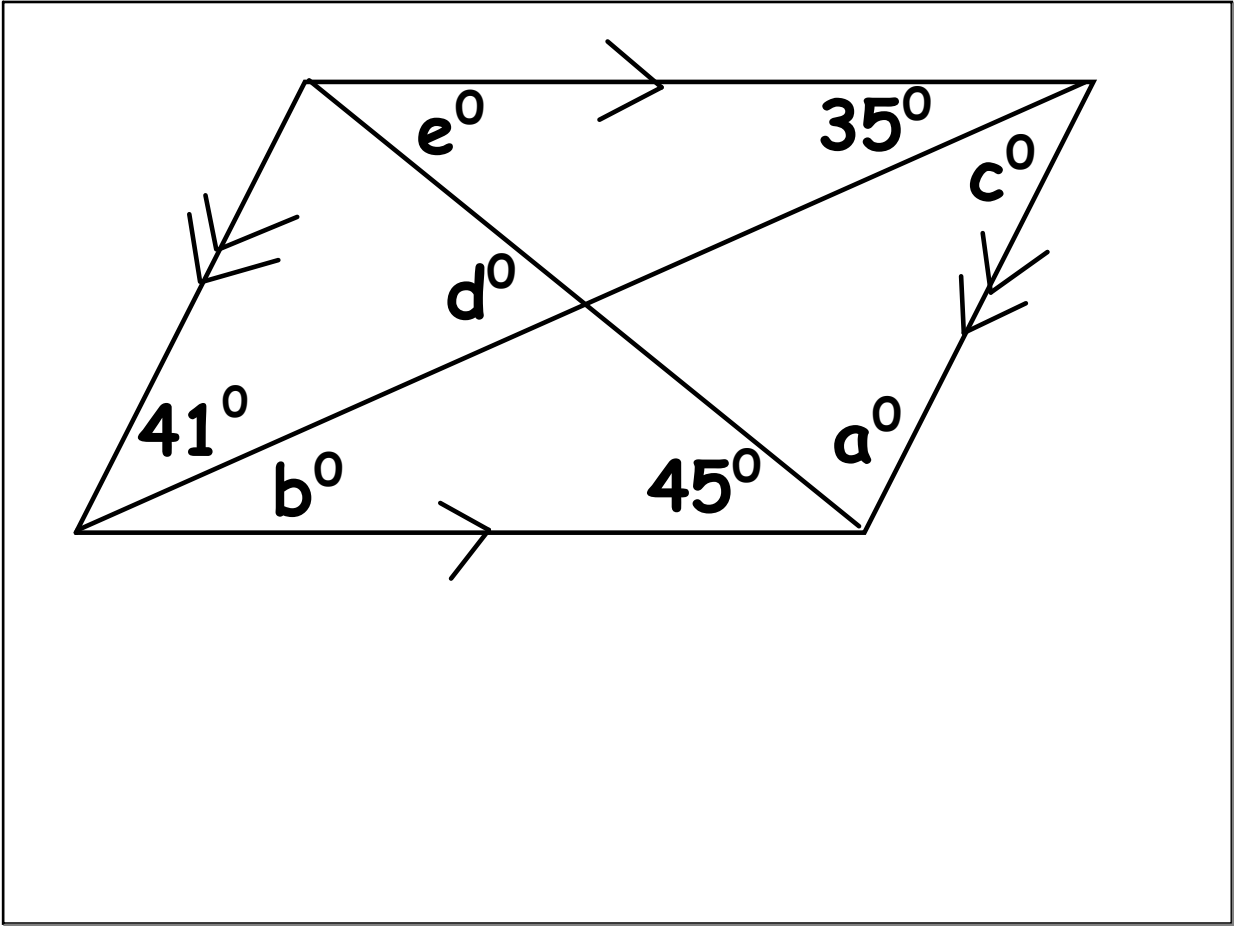

mai 29-20:16